

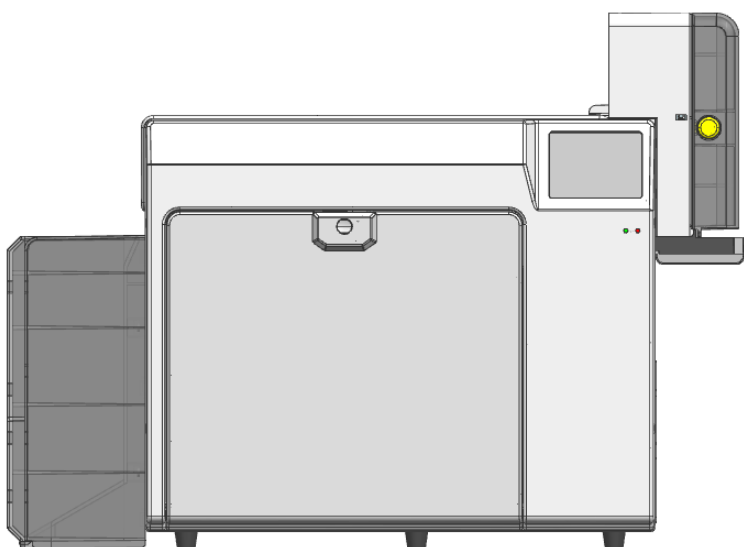

Desktop Retransfer Dual-sided Card Printer

Operation Instruction



Model: Seatory R330/R660

Shenzhen Seatory Technology Co., Ltd.

*Excellent Quality
Perfect Service*

Statement

- **Copyright**

Copyright© Shenzhen Seaory Technology Co.,Ltd. All rights reserved.

- **Copyright**

Users shall respect the latest regulations on copyright of their own countries. This manual, no matter in E-file, text version, or other formats, can never be partially or totally copied, translated or spread in any way for any reason, without the writing authorization from Shenzhen Seaory Technology Co., Ltd. Please forgive that any change of this manual will not be further noticed. Shenzhen Seaory Technology Co., Ltd. shall take no responsibility for any errors (if any) in this manual, accidental damage of printer, or losses caused by this manual contents.

All the pictures and specifications in this manual are made to help description, while the actual specifications shall be subject to order. If any query, please refer to the products specifications on the website of Shenzhen Seaory Technology Co., Ltd.

- **Warranty**

With respect to warranty conditions and restrictive clauses, please refer to the Warranty Card enclosed in the printer package. Thanks for choosing Seaory R Series card printer, to start a successful cooperation between us. A variety of high quality personalization of identification cards, visa cards, and membership cards etc. can be realized through simply operation of these card printers. You shall make sure that printer consumables you bought are from original manufacturer. To know more information, please visit our website: www.seaory.com. If any errors found, please let us know by mailing to: info@seaory.com.

- Sign Indicates



Special Warning Message



More In-depth Information Notice

- **Declaration**

Warning: This is a Class A product. In a domestic environment this product may cause radio interference in which case the user may be required to take adequate measures.

Catalogue

1. Product Features	1	7.2 Ribbon Type Setting	30
1.1 Main Function	1	7.3 Printing Orientation Setting	31
1.2 Features	1	7.4 Printing Page Rotate Setting	32
2. Product Parameter	2	7.5 Feeding Card Mode Setting	33
3. Product Introduction	3	7.6 Setting of Card Output Mode	34
3.1 Product Size	3	7.7 Defective Card Mode Settings	35
3.2 Roof	3	7.8 Image Color Settings	36
3.3 Back-end	4	7.9 Magnetic Encoding Setting	37
3.4 Front-end	5	7.10 Heating Energy Setting	38
3.5 Backside	5	7.11 Tool Setting	39
3.6 Internal Structures	6	7.12 Magnetic Stripe Tool	41
4. Accessories Included	7	7.13 Ribbon Tension Adjustment	42
4.1 Open-case Inspection	7	7.14 Tool	43
5. Installation and Usage	9	8. Print Test	44
5.1 Install Cleaning Roller	9	8.1 Driver Test Page	44
5.2 Consumables Installation	10	8.2 Seaory iCARDE Card Design Software	45
5.2.1 Consumables Preparation	10	9. Cleaning and Maintenance	46
5.2.2 Remove the Consumables Holder	11	9.1 Replace Cleaning Roller	46
5.2.3 Install the Ribbon and Transfer Printing Film	12	9.2 Cleaning Card Moving Path	46
5.2.4 Install the Consumables Holder	13	10. Touch Screen Operation Instructions	48
5.3 Install the Input Hopper	14	10.1 Main Interface Introduction	48
5.4 Install the Output Hopper	14	10.2 Menu	49
5.5 Adjust the Card Thickness	15	10.2.1 Printer Information	49
5.6 Install Cards and Place the Counterweight Card	15	10.2.3 Ribbon Information	49
5.6.1 Front-end Automatic Input Hopper	15	10.2.4 Module Information	50
5.6.2 Front-end Manual Single Input Card	17	10.2.5 Printer Settings	50
5.6.3 Back-end Manual Single Input Card	18	10.2.6 Printer Test	51
5.7 Hardware Connections	19	10.2.7 Cleaning Tool	52
6. Printer Driver Installation and Uninstallation	20	11. Common Fault Codes and Solutions	53
6.1 Operating System	20	11.1 No Action Occurred	53
6.2 Preparation Before Installation	20	11.2 Blank White Card Printed	53
6.3 Driver Installation Steps (USB interface)	21	11.3 Partial or Wrong Printing	53
6.4 Network Setting	24	11.4 Printing Defects	53
6.5 Driver Installation (Ethernet interface)	25	11.5 White Horizontal Lines Appear in the Print	54
6.6 Driver Uninstallation	26	11.6 White Vertical Lines or Color Lines Appear in the Print	54
7. Printer Driver Settings	29	11.7 Blurred Image in Printing	54
7.1 Printer Driver Preferences	29		

1. Product Features

1.1 Main Function

- A. Dual-sided printing
- B. Automatic batch feeding card
- C. Manual feeding card on the back end
- D. Alarm for no card, defective slot
- E. Combine feeding card mode and recycling pending card
- F. Perfectly over edge-to-edge printing of the entire card.
- G. With card bending correction function
- H. Multi-function optional modules:
 - ① Dual interface card encoding module;
 - ② Contactless card encoding module;
 - ③ UHF chip card encoding module;
 - ④ Magnetic stripe card encoding module;
- I. Support YMCK, YMCKK, YMCKI, YMCKHs and other colored ribbons, YMCUvK fluorescent anti-counterfeiting ribbons, monochrome black ribbons

1.2 Features

- Adopt high resolution transfer dye sublimation print method
- Standard 600dpi × 600dpi high resolution and dual-sided printing
- Higher image quality and clear text, professional-level printing effects
- Perfectly realize the entire card over-edge printing
- High printing speed
- All-metal movement, more stable continuous printing ability of card
- Support PVC, composite PVC, ABS, PET, PC and other materials to print high-quality cards
- With a 3.5-inch color touch-screen, the operation is more intuitive and convenient

2. Product Parameter

Product Name	Desktop Retransfer Dual-sided Card Printer
Print Method	Dye Sublimation (Retransfer-to-card)
Power Supply	DC24V, 15A
Print Dimension	ISO CR80 (53.98mm×85.60mm) edge-to-edge printing
Print Resolution	600dpi × 600dpi
Print Speed	Monochrome printing:12-16s per card(single-sided), 30-34s per card(dual-sided),using ribbon saving technology Full-color YMCK Printing: 20s per card(single-sided),38s per card(dual-sided)
Card Material	PVC, composite PVC, ABS, PET and PC materials
Card Thickness	0.3-1.05mm
Memory	256M
Input hopper capacity	200 cards (standard thickness card 0.76mm)
Output hopper capacity	200 cards (standard thickness card 0.76mm)
Defective card slot capacity	25 cards (standard thickness card 0.76mm)
Operation system	Support 32-bit and 64-bit Windows® XP, 7, 8, 10, Windows® Server 2003/2008/2012/2016/2019/2022; 32-bit and 64-bit Linux; Mac OS. Support Chinese operating systems, such as the NeoKylin, Kylin and UnionTech UOS.
LCM Display	3.5 inch color touch-screen
Operating condition	Regular running temp.: 15°C-30°C (59-86°F), 20%-65%,RH non-condensing Lowest / Highest running temp.: 0°C(32°F)/40°C(104°F), 20%-65% RH non-condensing
Storage condition	Temp.: -5°C-70°C(23-158°F), 20%-70% RH non-condensing

3. Product Introduction

3.1 Product Size

R660 card printer size: 568mm × 272mm × 398mm,

Net weight: 12Kg.

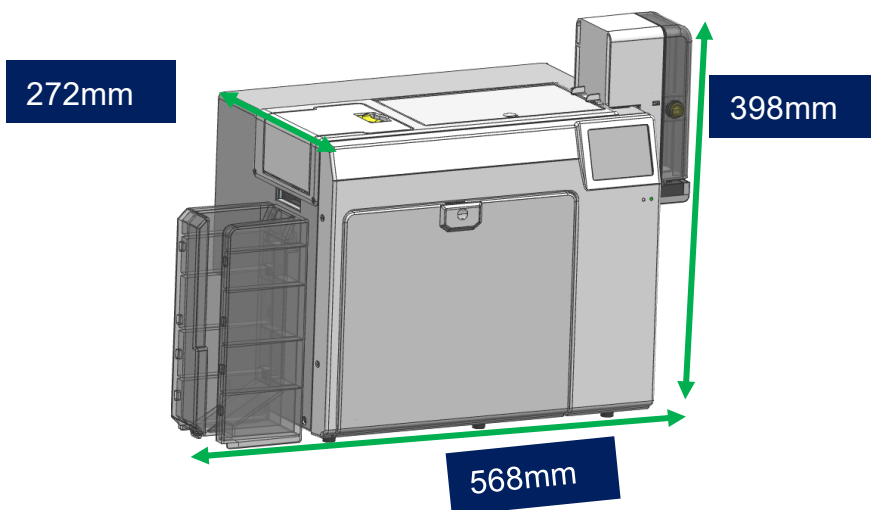

3.2 Roof

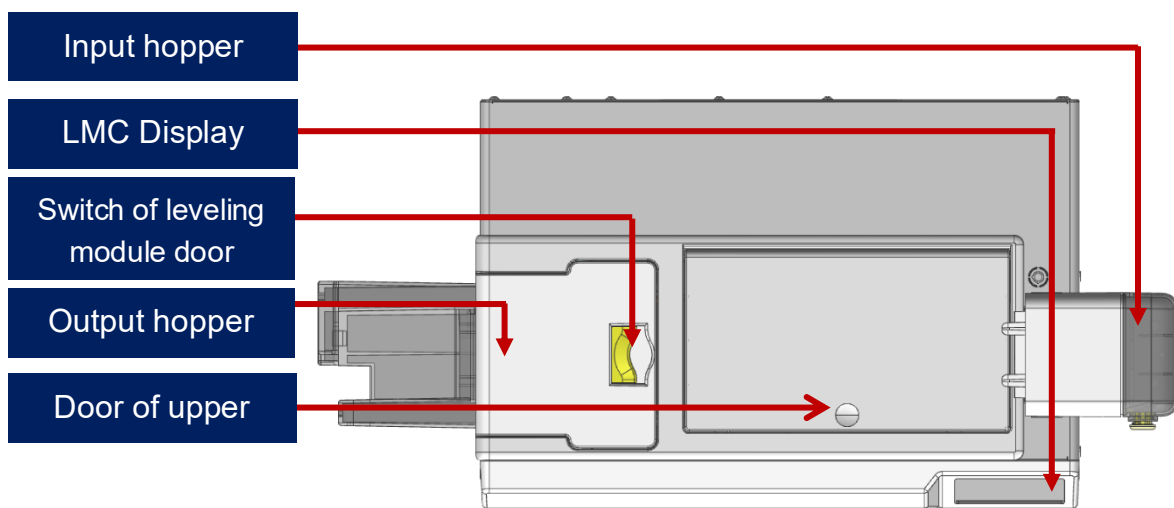

Main Function Description:

- 1.Input hopper: Card placement area to be printed (can hold 200 0.76mm standard cards).
- 2.Output hopper: Put the printed cards temporarily (can hold 200 0.76mm standard cards).
- 3.Switch of leveling module door: To open and inspect the leveling module.
- 4.Door of upper cover: Open the upper cover door to observe its internal working status and install the cleaning module.
- 5.LMC Display: Show printer parameter information and status information.

3.3 Back-end

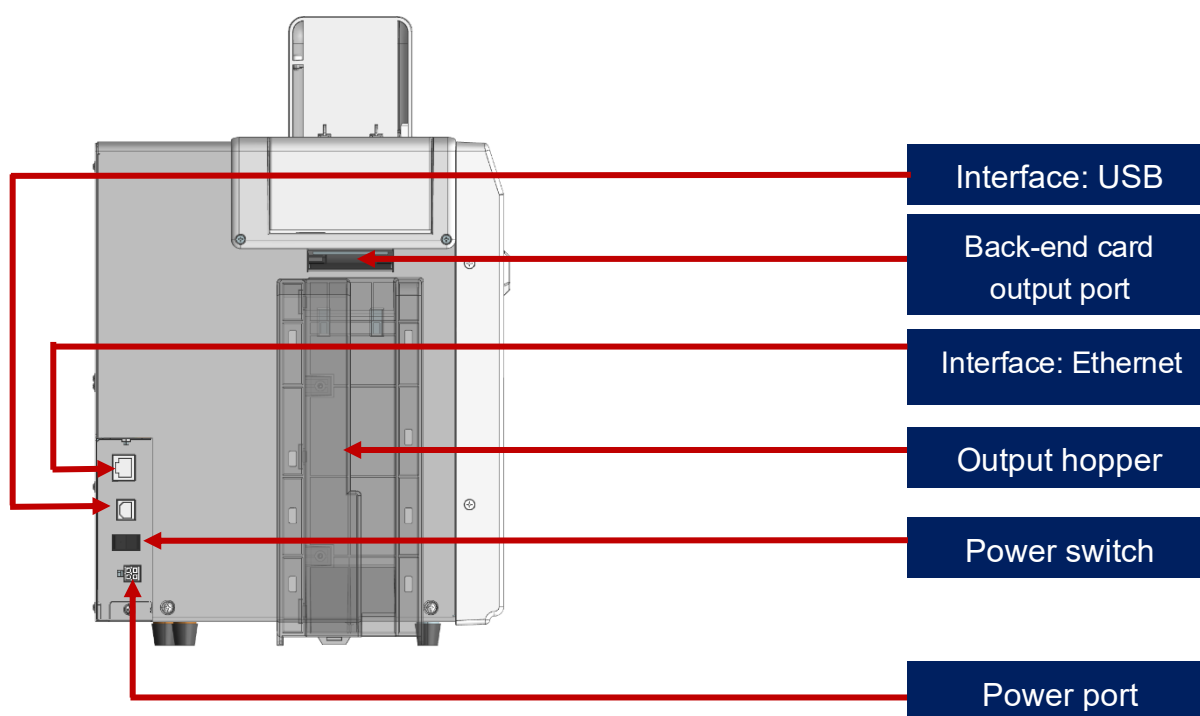

Main Function Description:

1. Ethernet Interface: RJ45 interface, TCP/IP protocol, through this interface can achieve PC and card printer network connection.
2. USB Interface: USB-B type interface, connect directly to PC side.
3. Power port: 24VDC, 15A.
4. Power switch: connect or disconnect power.
- 5.Back-end card output port, the printed card is ejected from here, support the back-end manual feeding card and recycling pending card.

The communication interface supports USB and Ethernet, It's recommend that to choose one of them

3.4 Front-end

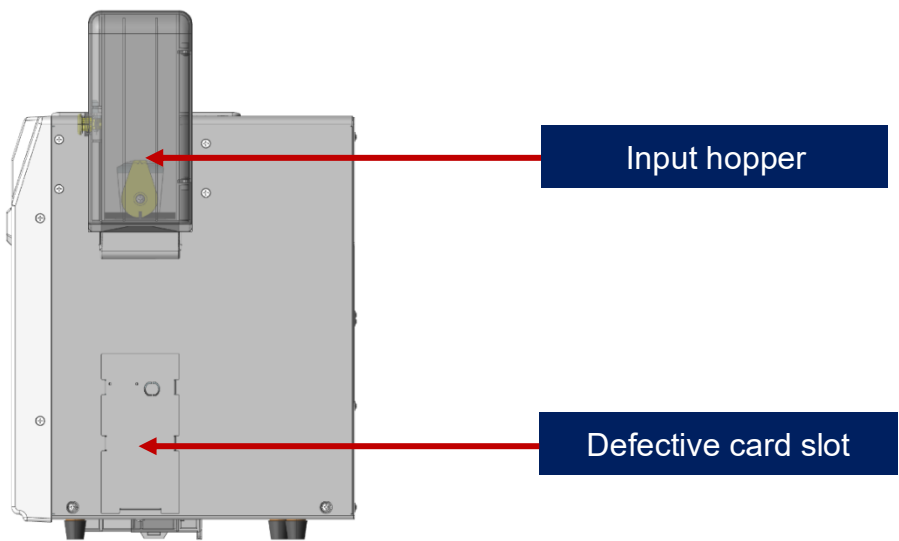

Main Function Description:

Input hopper: Blank card storage area, capacity: 200pcs standard card(0.76mm).

Defective card slot: Defective cards storage area, capacity: 25pcs standard card(0.76mm).

3.5 Backside

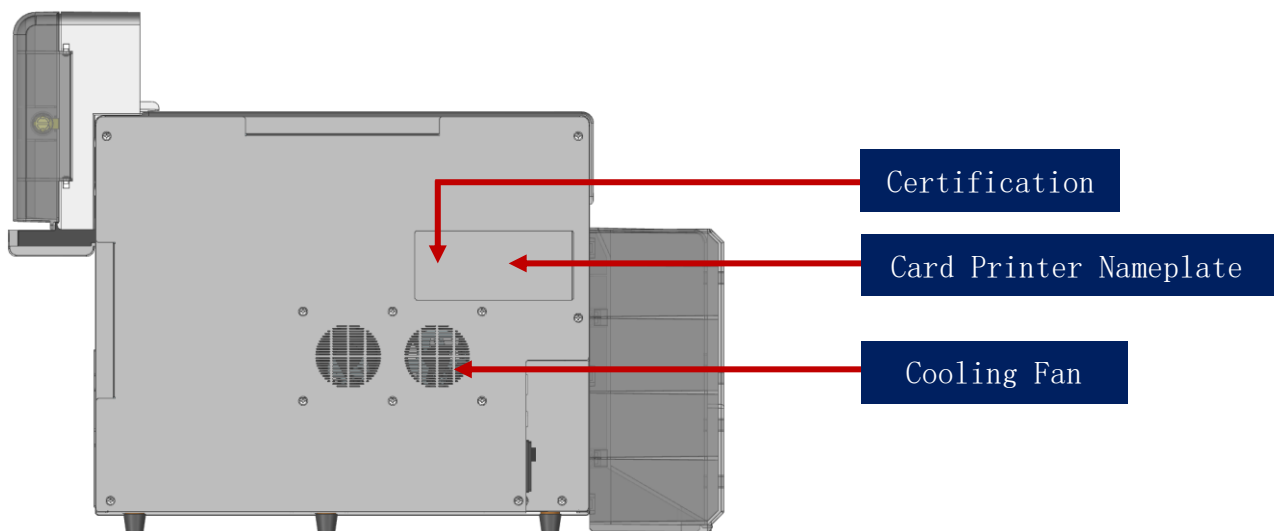

Main Function Description:

Open the backside cover to install the IC card encoding module.

Card printer nameplate: Barcode information on nameplate is needed when you need technical services from us.

3.6 Internal Structures

(1) Right View

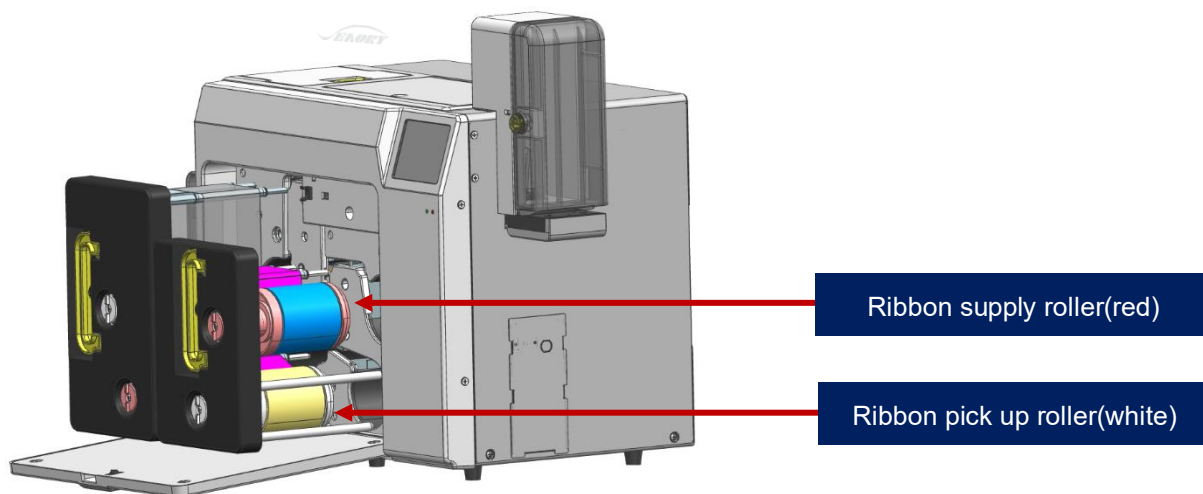

Main Function Description:

Ribbon supply roller: unused ribbon ends.

Ribbon pick up roller: recycle used ribbon.



When purchasing the printer, the ribbon and transfer film are not installed in the equipment as standard. It needs to be purchased separately.

(2) Left View

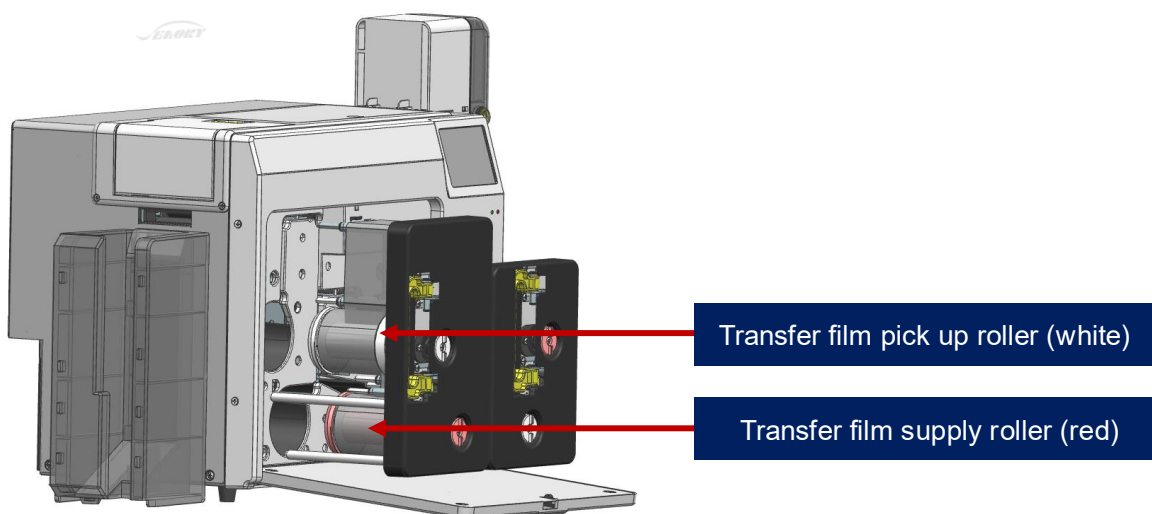

Main Function Description:

Transfer film pick up roller: unused ribbon ends.

Transfer film supply roller: recycle used ribbon.

(3) Consumables View

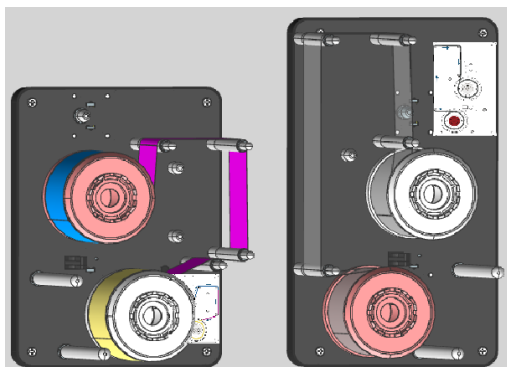

i When purchasing the printer, the ribbon and transfer film are not installed in the equipment as standard. It needs to be purchased separately.

4. Accessories Included

4.1 Open-case Inspection

After opening the box, first check whether the appearance is in good condition, and check whether the accessories are complete according to the product instruction manual (prevailed by the sales contract). If there is any missing, please contact the dealer to communicate and solve.

					
x1	x1	x1	x1	x1	x5
					
x1	x1	x1	x1	x1	x1

Main Function Description:

Input hopper: Card placement area to be printed (can hold 200 0.76mm standard cards).

Output hopper: Put the printed cards temporarily (can hold 200 0.76mm standard cards).

Power cable: connect to power adapter.

USB cable: communication connection between PC and card printer.

Counterweight card: Apply gravity to the card to increase the contact area between the card and the card feed wheel, ensuring stable card feed when the number of cards in the card feed slot is small.

Cleaning module and cleaning roller: indirectly stick to the dust on the card surface to improve the printing effect.

Cleaning card: double-sided 3M standard card, cleaning card printer internal card passing channel dust.

Warranty card: need to use it while supply technical service, please keep it properly.

Cleaning stick: cleaning the print head.

CD: storage ICARDE software, card printer driver, Operation instruction etc.

5. Installation and Usage

5.1 Install Cleaning Roller

Step1: Take out the cleaning module and cleaning roller from the accessory box, and assemble them as required by the following picture.

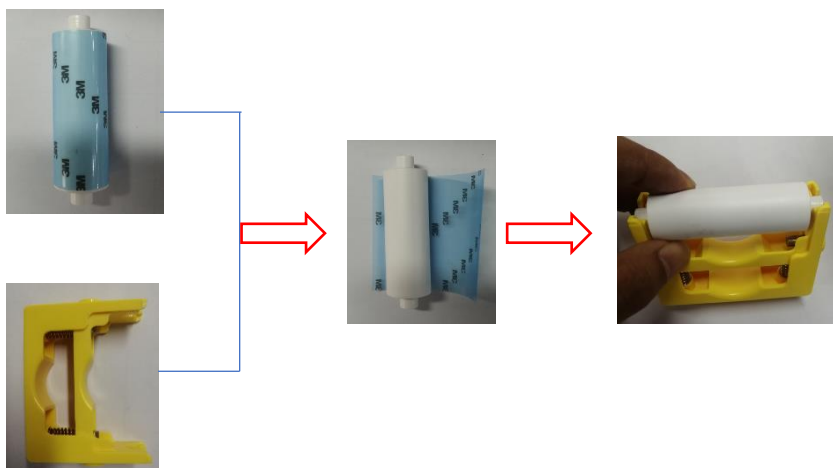

After tearing off the 3M adhesive layer on the surface of the cleaning roller, hold the two ends of the cleaning roller with hands, push them to the installation position and gently press down to lock until the ends do not fall off.

Step 2: Press the red frame part of the upper cover door in the lower left picture, and open the upper cover door by hand after the upper cover lock pops out

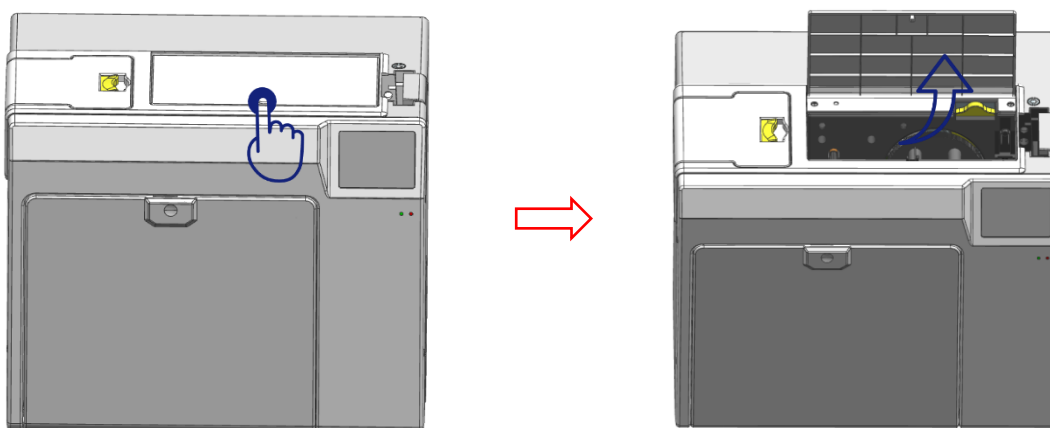

Step 3: Install the above assembled cleaning module into the card printer as shown in the picture below:

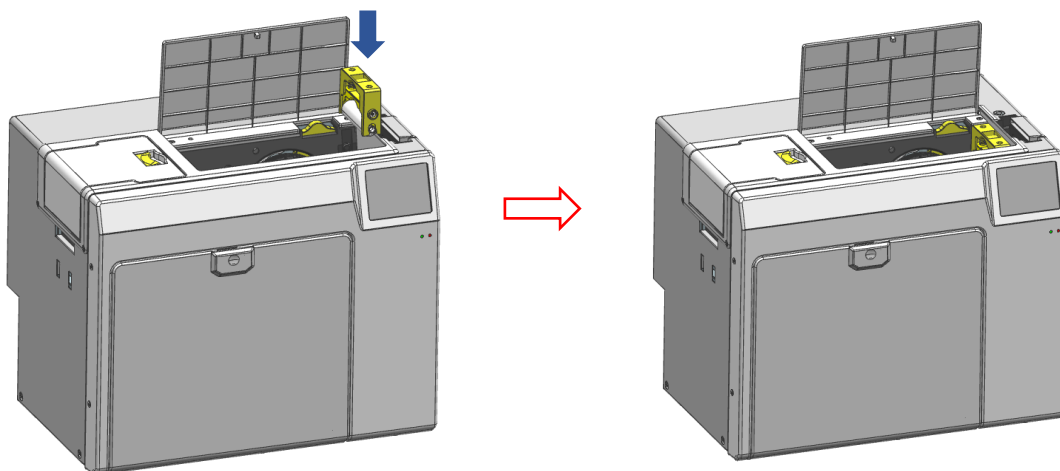

The function of the cleaning roller is to absorb the dust and foreign matter entering the card roller, indirectly stick to the dust on the card surface to improve the printing effect.

5.2 Consumables Installation

5.2.1 Consumables Preparation

Take out the ribbon and transfer printing film from the consumable packaging box, open the corresponding blister boxes respectively and take out the ribbon and transfer film.



Transfer film



YMCK ribbon



In order to ensure the normal use of the printer, please use the original Seatory ribbons.

5.2.2 Remove the Consumables Holder

Pull the ribbon door ring as shown below, open the ribbon door, turn the handle of the consumable holder, and take out the consumable holder.

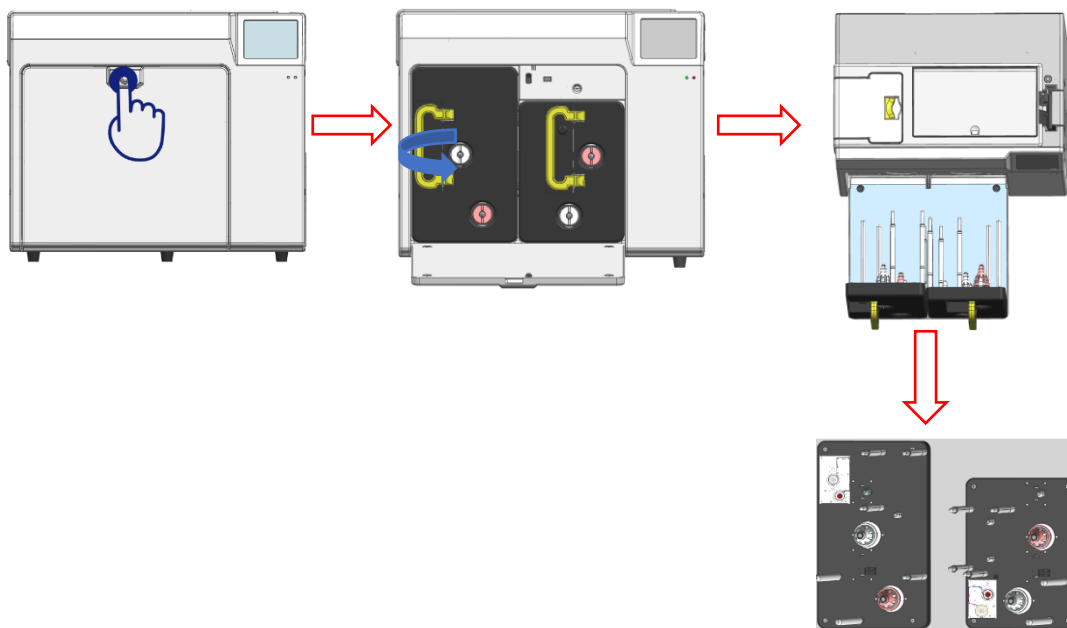

Warning: When card printer shipped from the factory, there will be placed a piece of sponge paper next to the print head, please take it off before use or the power on test, otherwise it may cause damage to the printhead. Operation steps are as follows.

As shown in the picture below, follow the operating guidelines to remove the right ribbon holder, and then remove the sponge paper as shown.

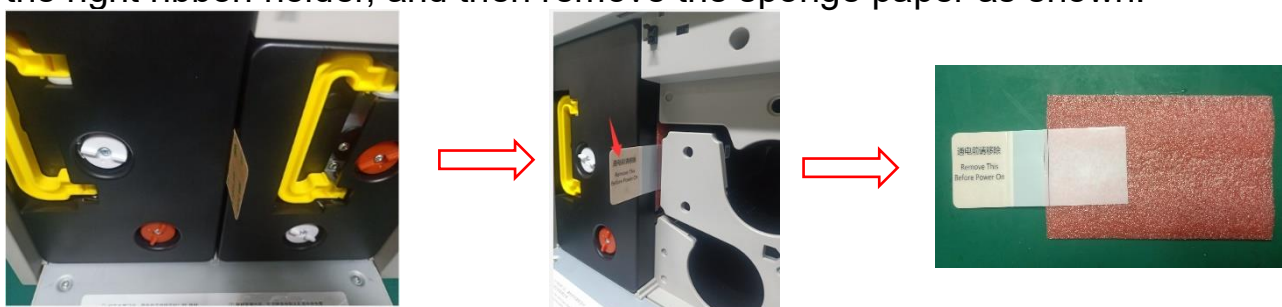

5.2.3 Install the Ribbon and Transfer Printing Film

Install the transfer film and ribbon into the consumable holder as shown below.

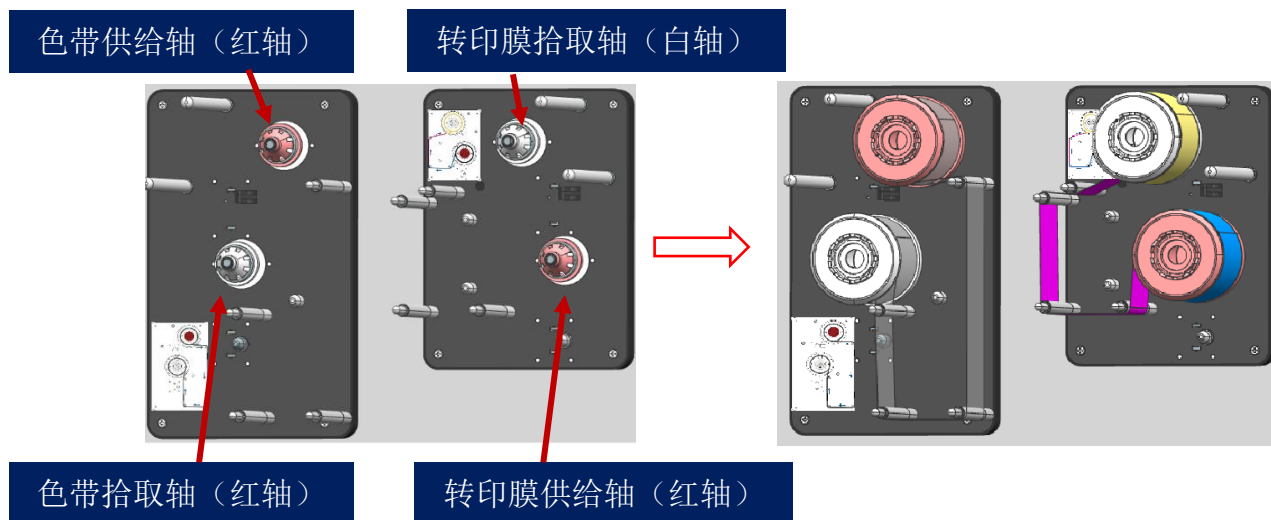

Supply shaft: the red end is the supply shaft, unused consumables (ribbon or transfer printing film);

Pick up shaft: the white end is the pick up shaft, used consumables (ribbon or transfer film);

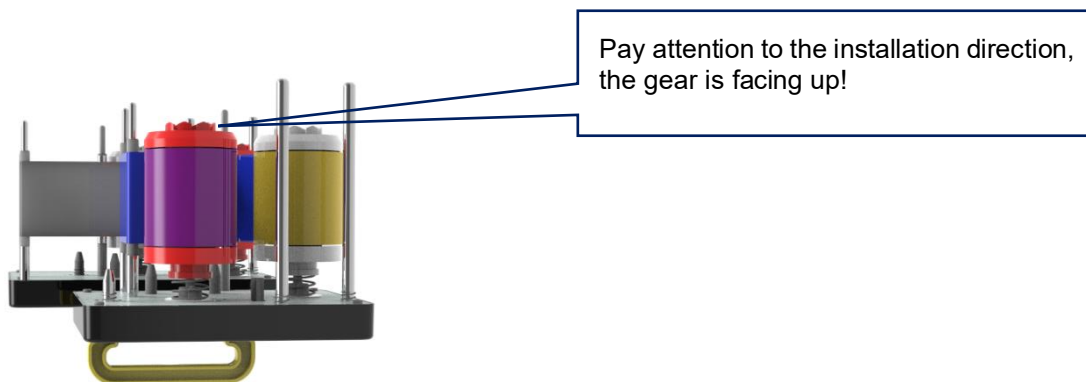

5.2.4 Install the Consumables Holder

Install the consumable rack with the ribbon and transfer film installed into the card printer.

(1) Align the post of the transfer film holder with the hole as shown in the picture above and gently push it into the card printer.

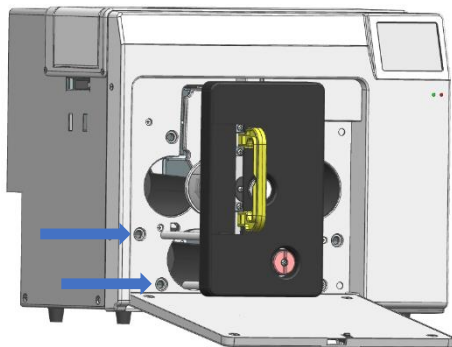

(2) Align the post of the ribbon holder with the hole as shown in the picture above, and gently push it into the card printer.

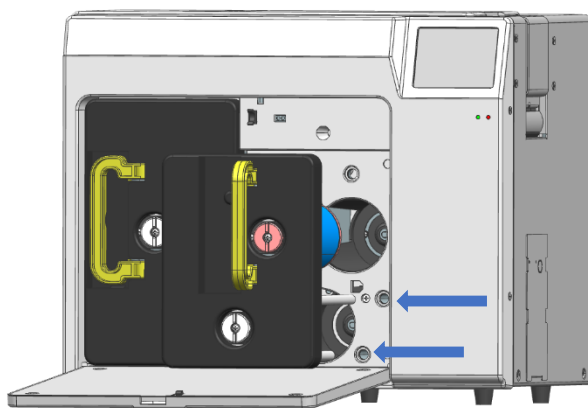

(3) Close the ribbon door and complete the installation of the consumables support.

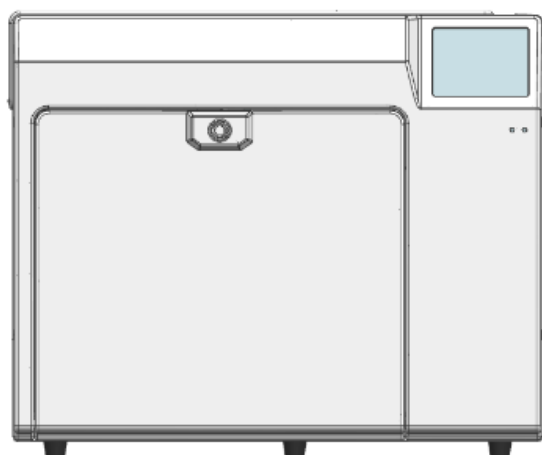

5.3 Install the Input Hopper

First take out the card slot from the accessory box, turn 90° to open the card slot, and then press the slot to the end vertically as shown in the figure below

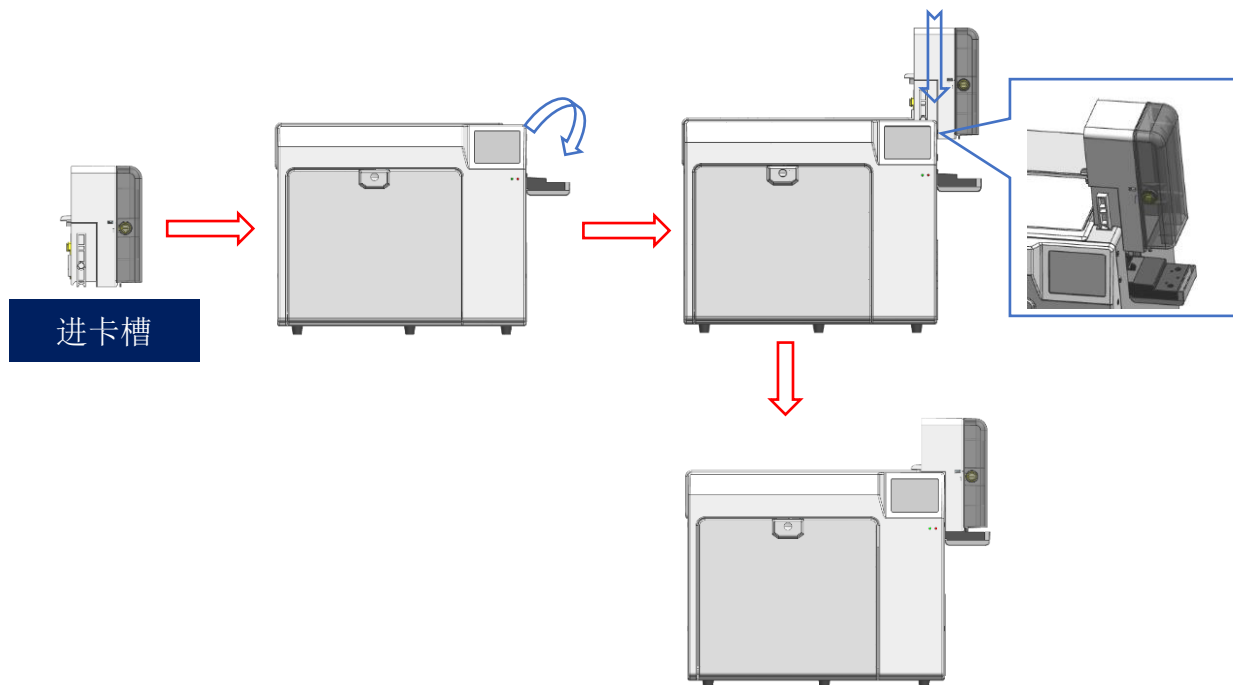

5.4 Install the Output Hopper

Take out the card slot from the accessory box. There are two holes under the card outlet at the back of the card printer. Insert the card slot hooks into the two holes below the card outlet as shown in the picture below.

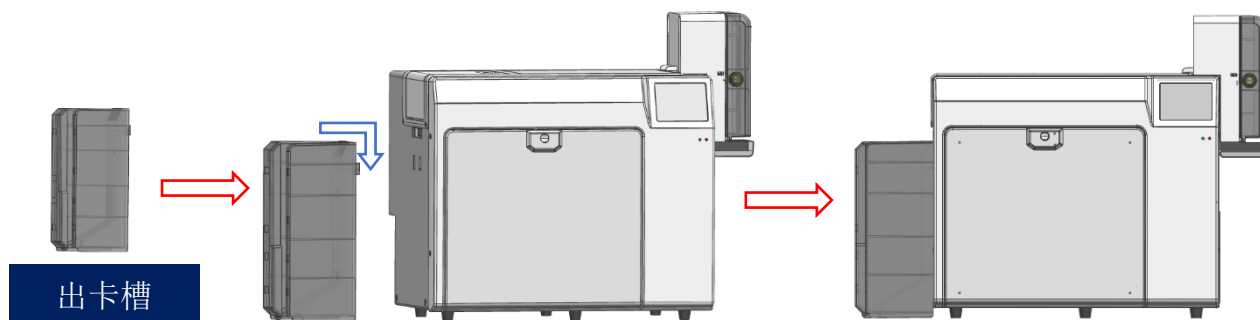

i The printed card is temporarily stored in the card output slot, please keep it properly.

5.5 Adjust the Card Thickness

Take out the card slot from the accessory box or take out the card slot from the card printer front end. According to the card thickness, turn the yellow control button to adjust the card thickness.

The factory default thickness of the Input hopper is 0.8mm (30Mil), user can adjust it according to the actual thickness of the card.

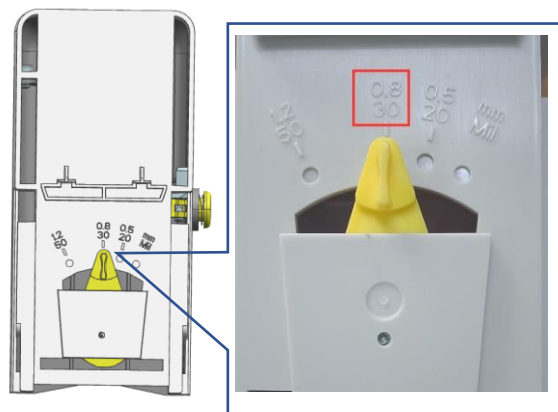

5.6 Install Cards and Place the Counterweight Card

5.6.1 Front-end Automatic Input Hopper

(1) Introduction of Using the Card Slot

Press the yellow button into the card slot, and turn the door cover 90° to open the card slot door as shown in the picture below.

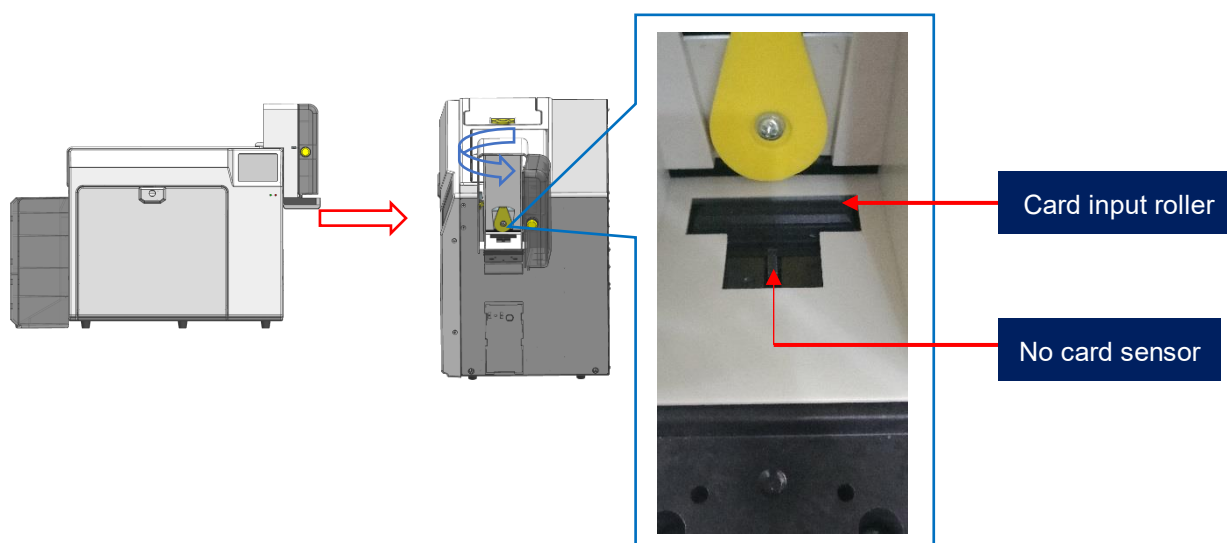

(2) Install Cards

You can put cards into the card slot after the card printer installation is completed.

- There is no requirement for the direction of contactless IC cards and ordinary white cards, the card insertion direction can be customized according to needs.
- The contact IC card should be inserted strictly in accordance with the card direction in the picture below, which is consistent with the ATM card insertion rules. If you only need to print and don't need to encode chip data, there is no requirement for the direction of the card. The card insertion direction can be customized according to needs.

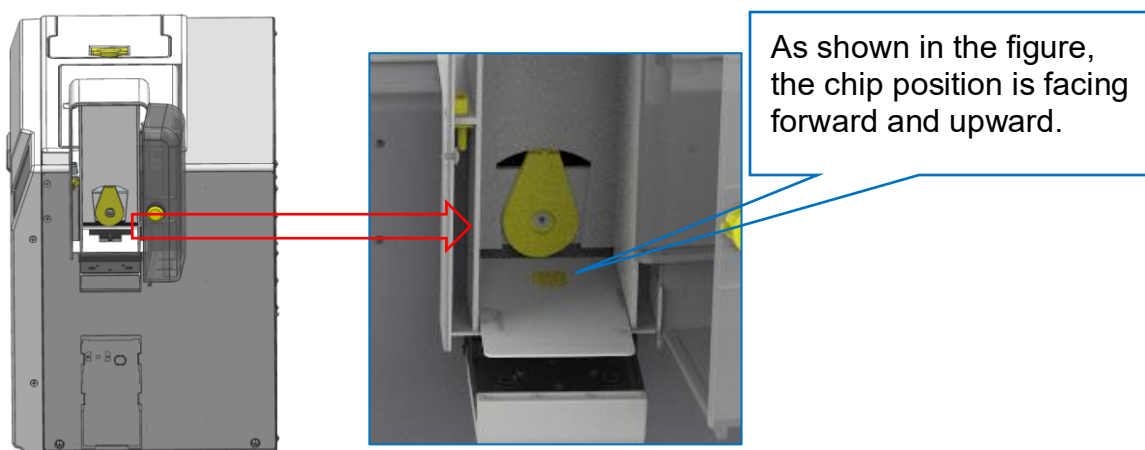

- ISO7811 standard magnetic stripe card should be inserted strictly in accordance with the card direction in the picture below, which is consistent with the ATM card insertion rules. If you only need to print and don't need to encode chip data, there is no requirement for the direction of the card. The card insertion direction can be customized according to needs.

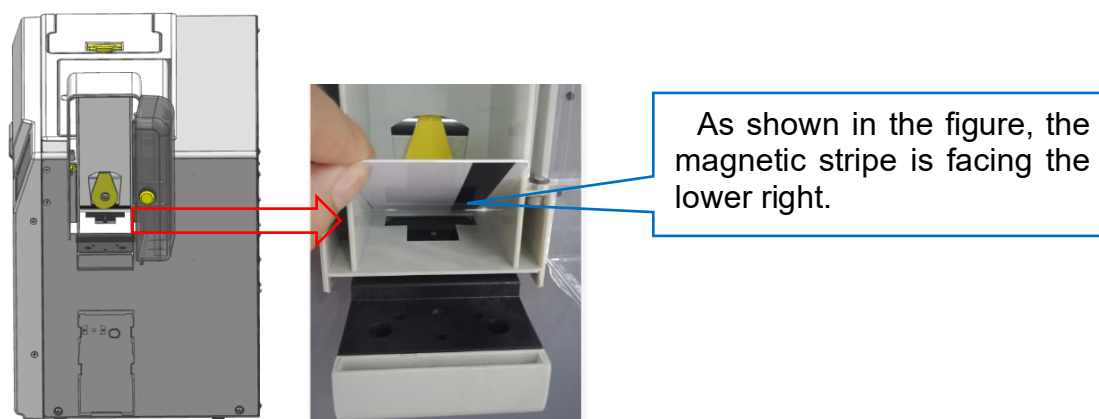

(3) Place Counterweight Card

Take out the counterweight card from the accessory box after installing the card and place it in the card slot.

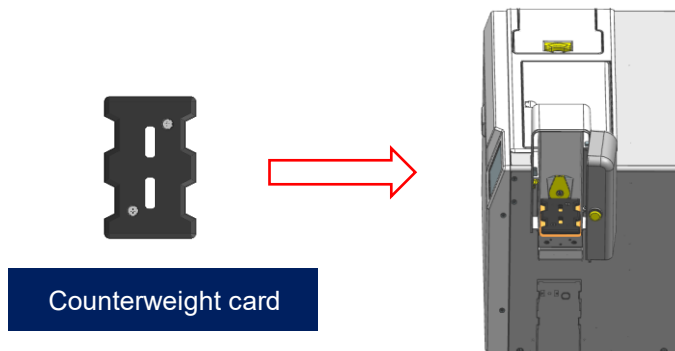

i Counterweight card: Apply gravity to the card to ensure stable card insertion when the number of cards in the card slot is small.

5.6.2 Front-end Manual Single Input Card

After taking out the card out slot, the front end can be manually inserted and ejected by rotating the card base. When the card printer is ready, put the card into the front entry/exit port, the machine will automatically swallow the card into the internal track of the device after detecting the card.

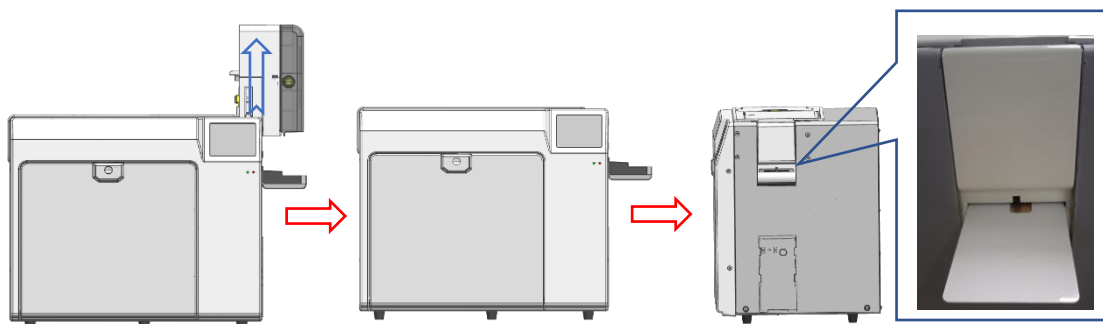

The card inserting direction of contactless IC card, ordinary white card, contact IC card, and magnetic stripe card is the same as the requirements for automatic front-end card slot insertion in [5.6.1](#)

5.6.3 Back-end Manual Single Input Card

In addition to the front-end batch automatic card feeding function, this model also supports the back-end manual single card feeding function. When the card printer is ready, put the card into the front entry/exit port, the machine will automatically swallow the card into the internal track of the device after detecting the card.

- There is no requirement for the direction of contactless IC cards and ordinary white cards, the card insertion direction can be customized according to needs.
- The contact IC card should be inserted strictly in accordance with the card direction in the picture below, which is consistent with the ATM card insertion rules. If you only need to print and don't need to encode chip data, there is no requirement for the direction of the card. The card insertion direction can be customized according to needs.

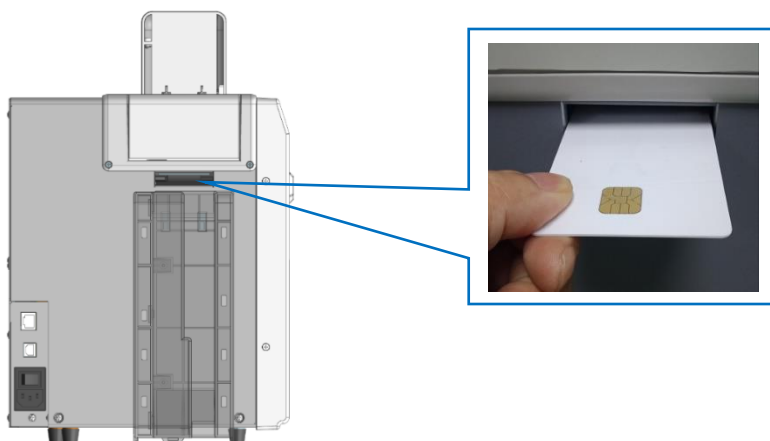

- The ISO7811 standard card should be inserted strictly according to the card direction in the picture above, so that the magnetic stripe position is at the bottom right of the card, which is consistent with the ATM card insertion rules. If you only need to print and do not need to encode magnetic stripe data, there is no requirement for the card direction, it can be customized according to your needs

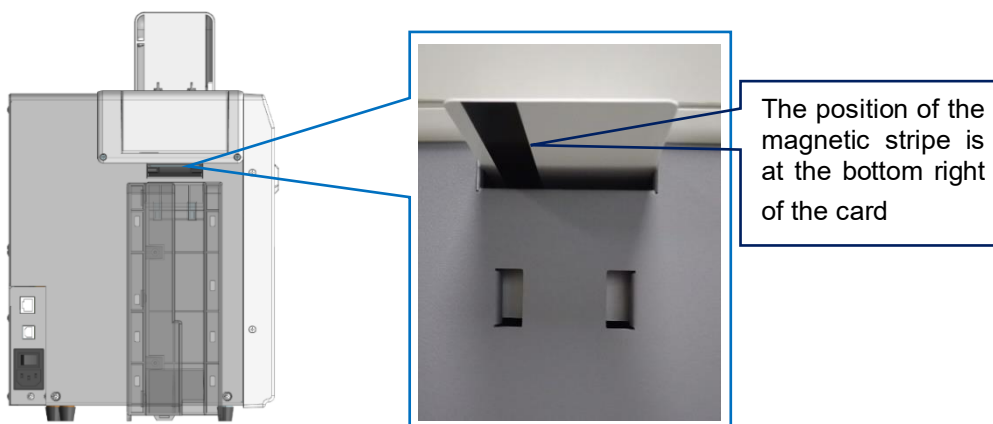

5.7 Hardware Connections

Take out the power cable and USB data cable from the accessory box of the card printer's outer packing box. The USB-A type interface is connected to the computer, and the USB-B type interface is connected to the USB interface of the printer.

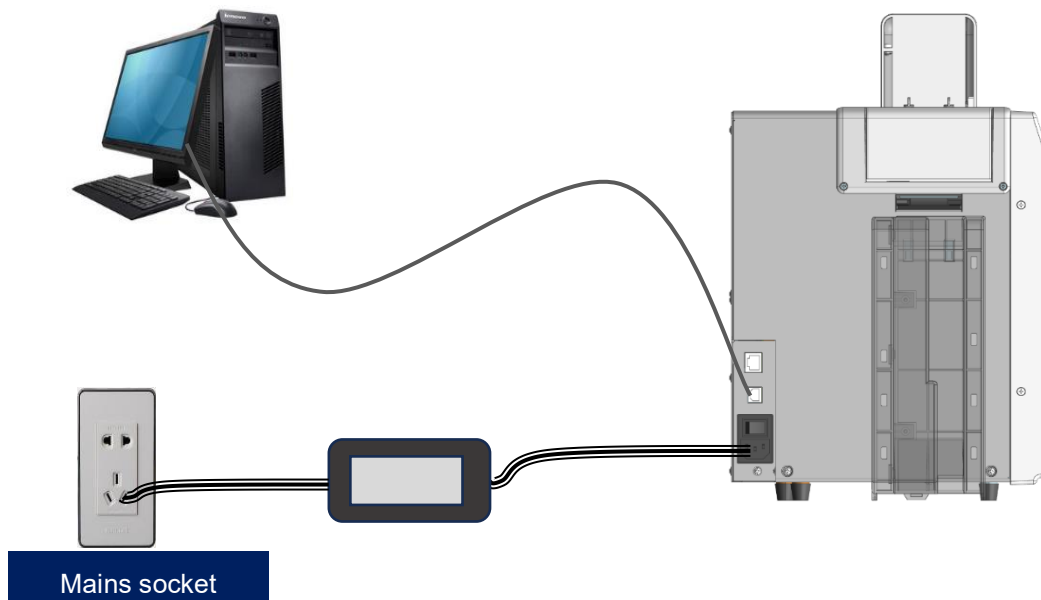

Ethernet communication interface installation: RJ45 network interface ,568B connection mode.

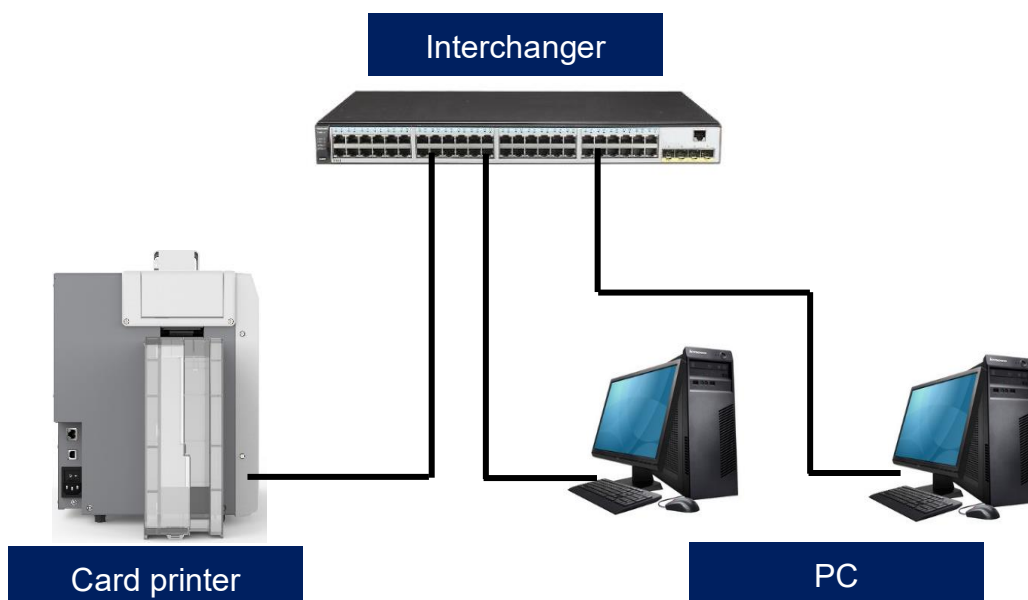

i Support USB and Ethernet communication interface. It's recommended to choose one.

6. Printer Driver Installation and Uninstallation

6.1 Operating System

Support operating system: Windows XP/7/8/10, Windows Server 2003/2008/2012/2016/2019/2022, Linux, Android, Mac OS

6.2 Preparation Before Installation

(1) Obtain the driver installation package: the CD-ROM in the accessory box or download it from the company's official website www.seaory.com

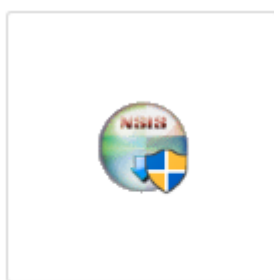

Seaory_R_series_driver
-x.x.x.x.exe



The driver will be continuously updated, the version number is subject to the actual version.

(2) Some antivirus applications will stop the driver installation, so please close all antivirus applications before installation. After finished, you can open all antivirus applications.

(3) Please do not power on card printer until the driver installation is completed.

(4) Connect card printer power supply and USB communication interface in advance (please refer to 5.5 wiring installation).

6.3 Driver Installation Steps (USB interface)

Step 1: Double-click “Seatory R series driver exe”.

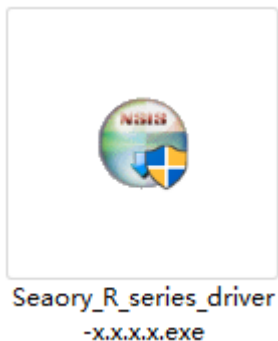

i Please install driver by administrator and close all antivirus applications before installation.

Step 2: Then click “Install” button as show in below picture.



Step 3: Wait for one minute.

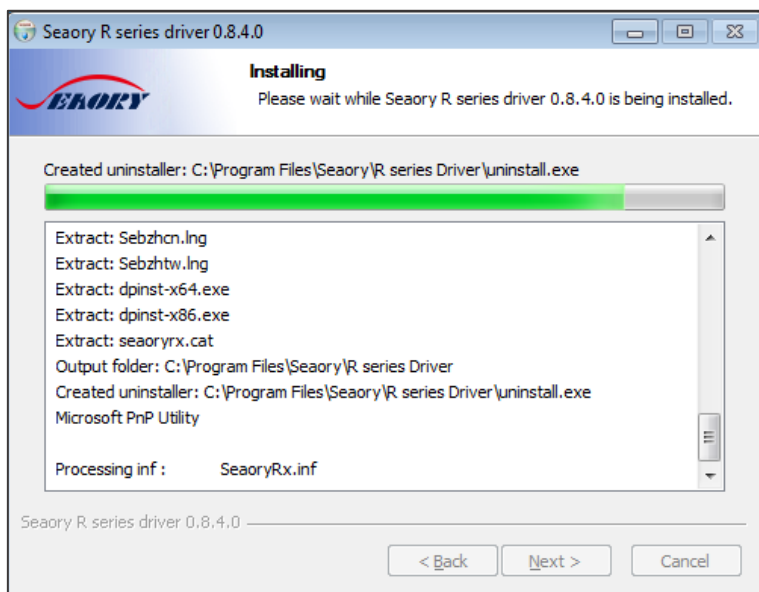

Step 4: Please select always trust software from “Shenzhen Seaory Technology Co., Ltd.” in the pop-up windows, then click the “Install” button.

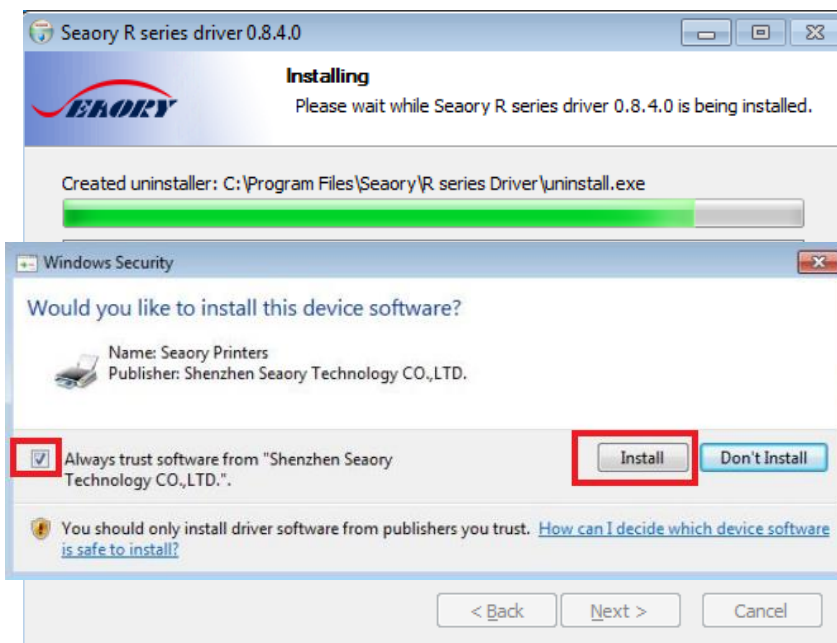

Step 5: Please click the “Finish” button as show in the below picture, then the driver has been installed.

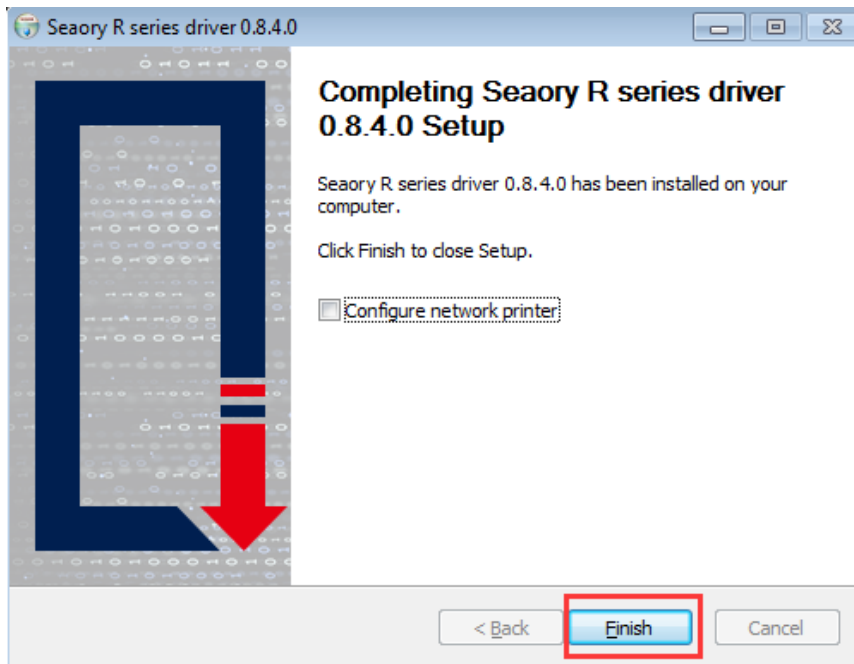

Step 6: Turn on the card printer power switch, then card printer driver will install automatically.

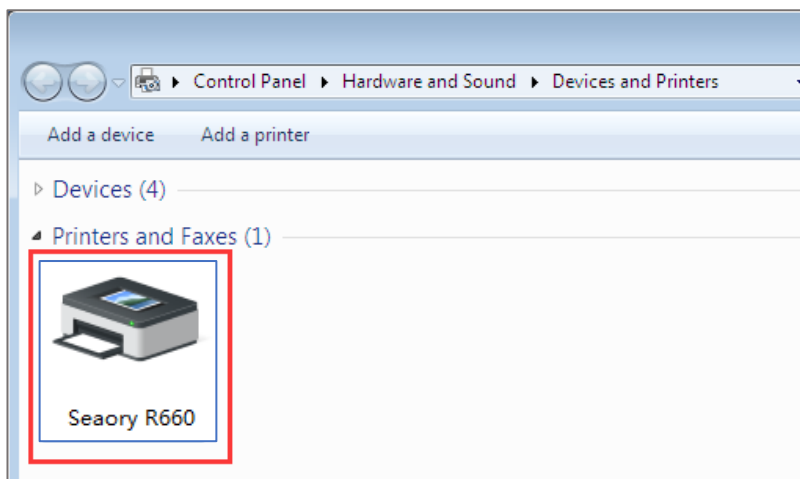

After the installation is successful, there will be a printer with the name "Seaory R660" in a red frame in the "Devices and Printers" of "Hardware and Sound" in the "Control Panel"

6.4 Network Setting

If you need to use Ethernet communication interface, please make sure the USB interface was connected with PC before operating as below:

Step 1: Put your mouse on the selected “Seatory R660” printer, and click the right button, from the Printer menu, select “Printing preferences”.

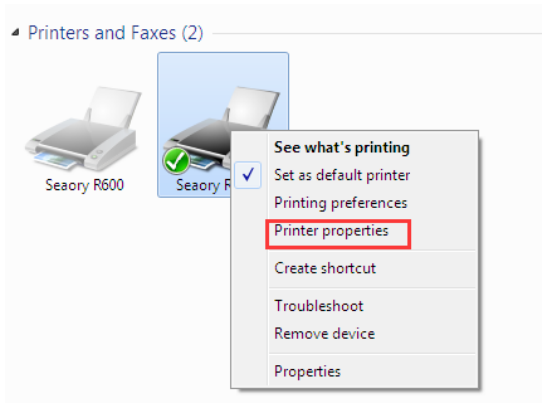

Step 2: Select “Tool” – “Network Setting”

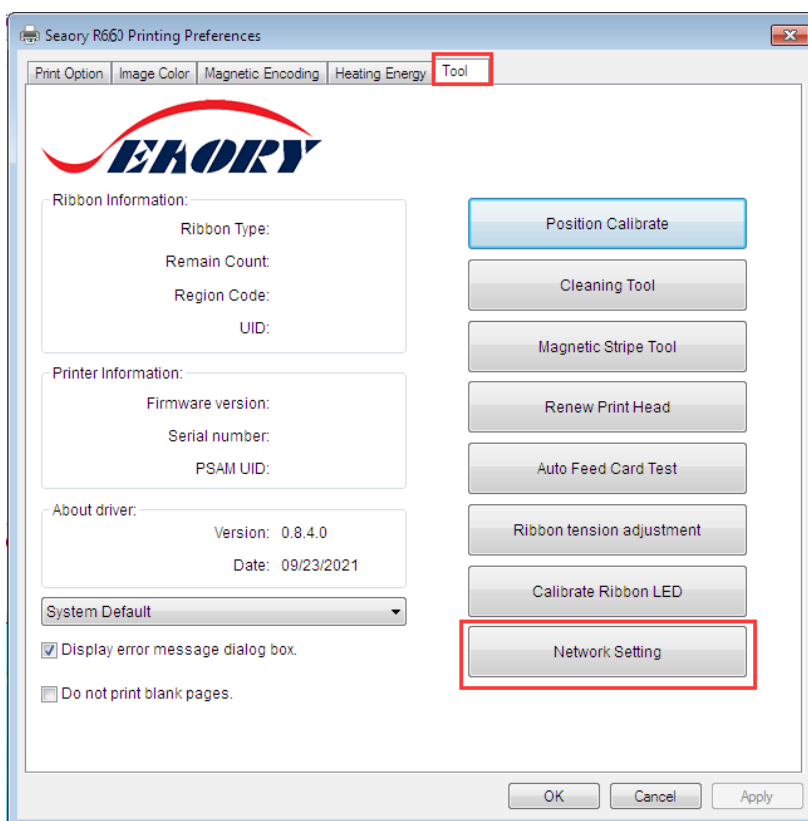

Step 3: After click “Network setting”, choose “Gets current setting”, you will find the card printer Model, firmware version, MAC address etc.

Step 4: Click “Static IP”, type in internet IP address, subnet mask, gateway information. Then click “Apply to printer”, you will see success dialog box. That means the network setup successfully.

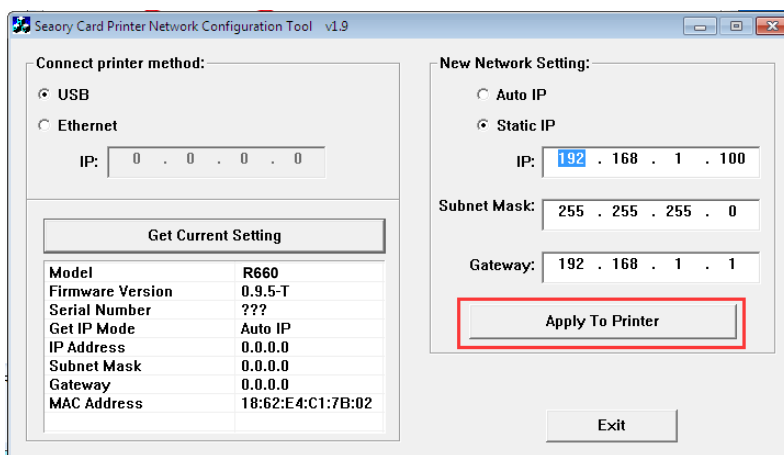

i After setting successfully, you can use the Ping network command to test the result.

6.5 Driver Installation (Ethernet interface)

According to [“6.4 network setting operating guide”](#), setting up the printer IP information, access to the network line and using the Ping command on the computer side to confirm the printer is communicating with the computer.

After finished [“6.3 driver installation \(USB communication interface\)”](#) operating guide, please operate according to following steps:

- (1) Select “Configure network printer” first, and then click “Finish”.

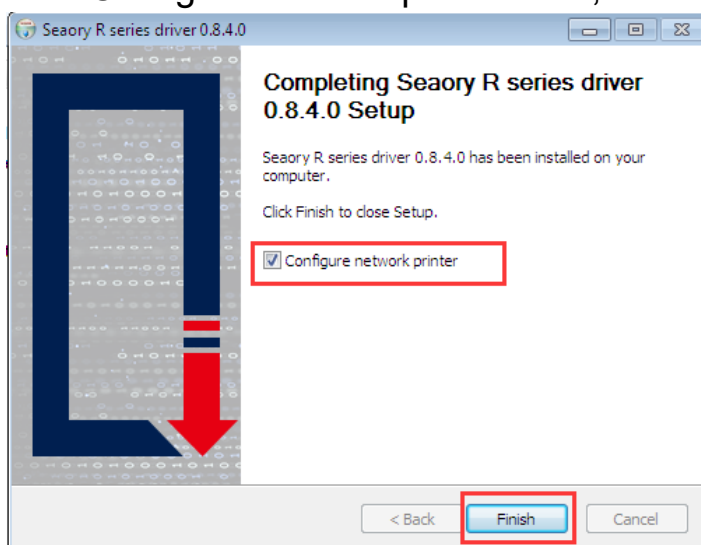

(2) Enter the IP address of the card printer, and then click "Add Printer" to complete the installation.

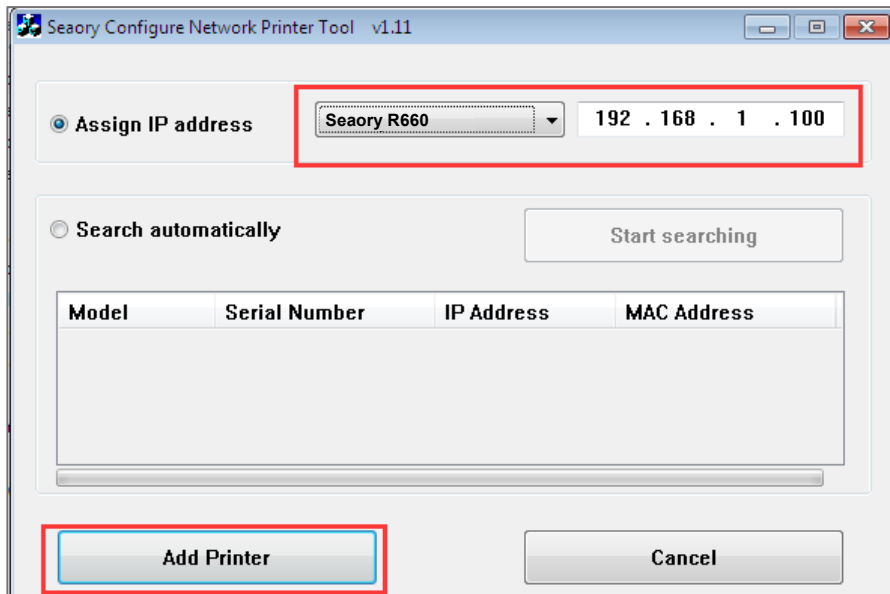

6.6 Driver Uninstallation

The method of uninstalling the Seatory R series card printer driver is the same as most of other software. This chapter will take the windows 7 operating system as an example.

(1) Click "Start" in the lower left corner of the system, and then click Control Panel;

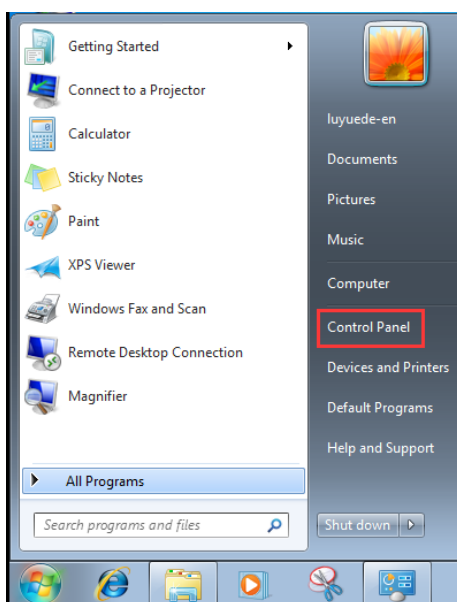

(2) After the control panel, we click “uninstall the program”;

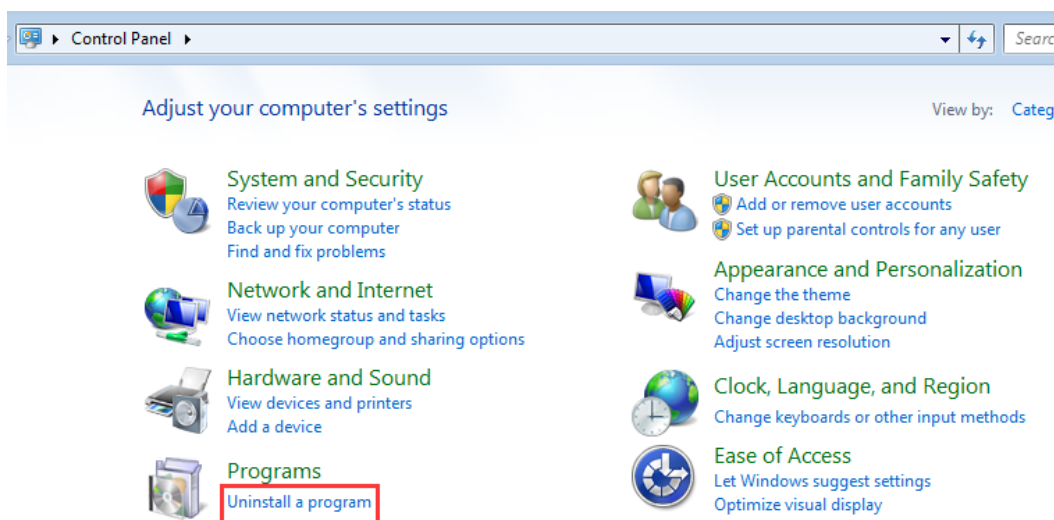

(3) As shown in the picture below, after the uninstallation program interface is opened, we will see the software "Seatory R series card printer driver" installed in the system.

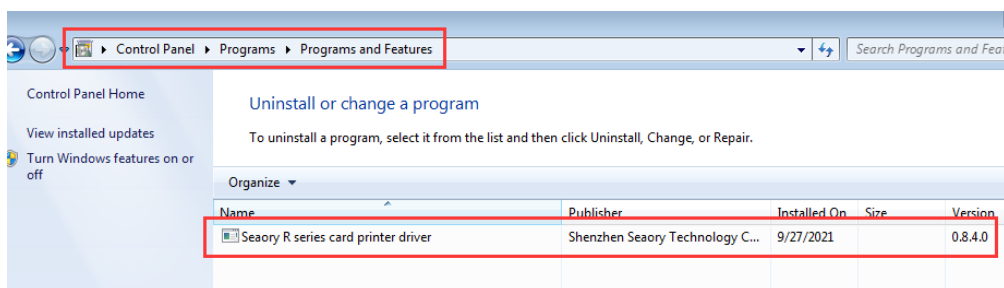

(4) Select "Seatory R series card printer driver" in the software catalog, right-click, and select the "Uninstall (U)" button.

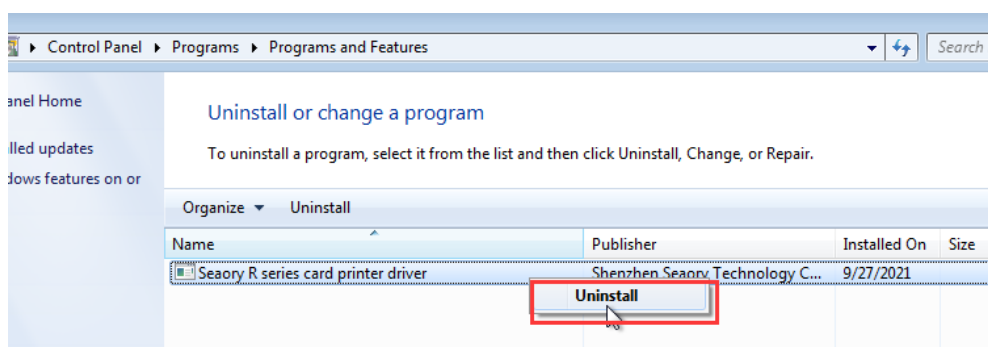

When the following interface pops up, click the "Uninstall (U) button" again to start the automatic software uninstallation;

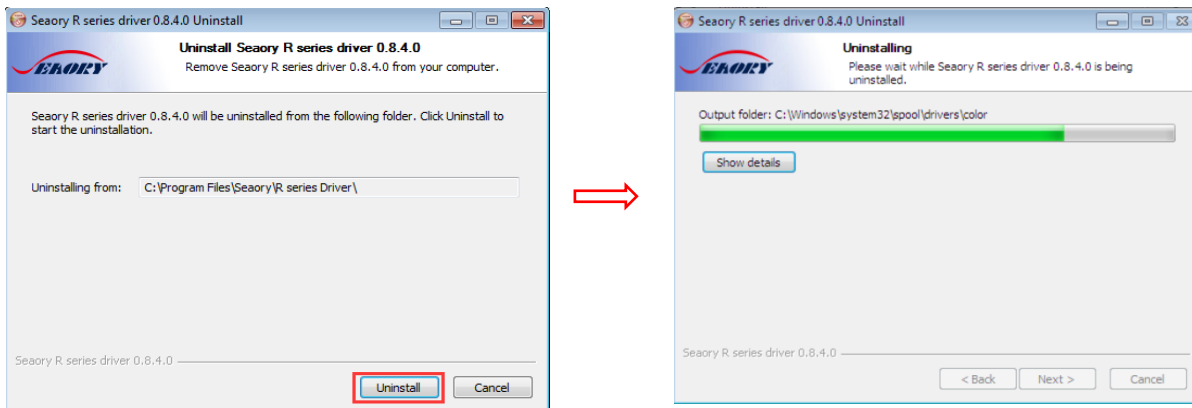

(5) Click the "Finish" button in the interface below to complete the software uninstallation

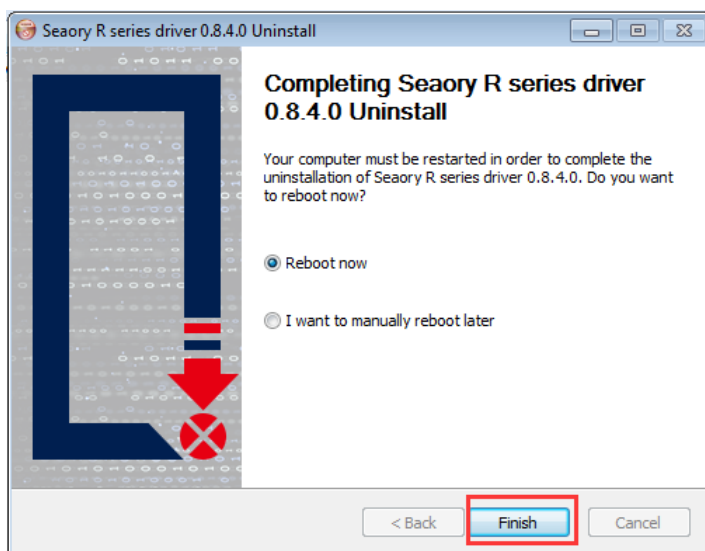

As shown in the above pop-up window prompting requirements, users can choose whether to restart the computer immediately according to their needs.

7. Printer Driver Settings

7.1 Printer Driver Preferences



Put your mouse on the selected "Seatory R660 printer", and click the right button, from the printer menu, select "Printing preferences".

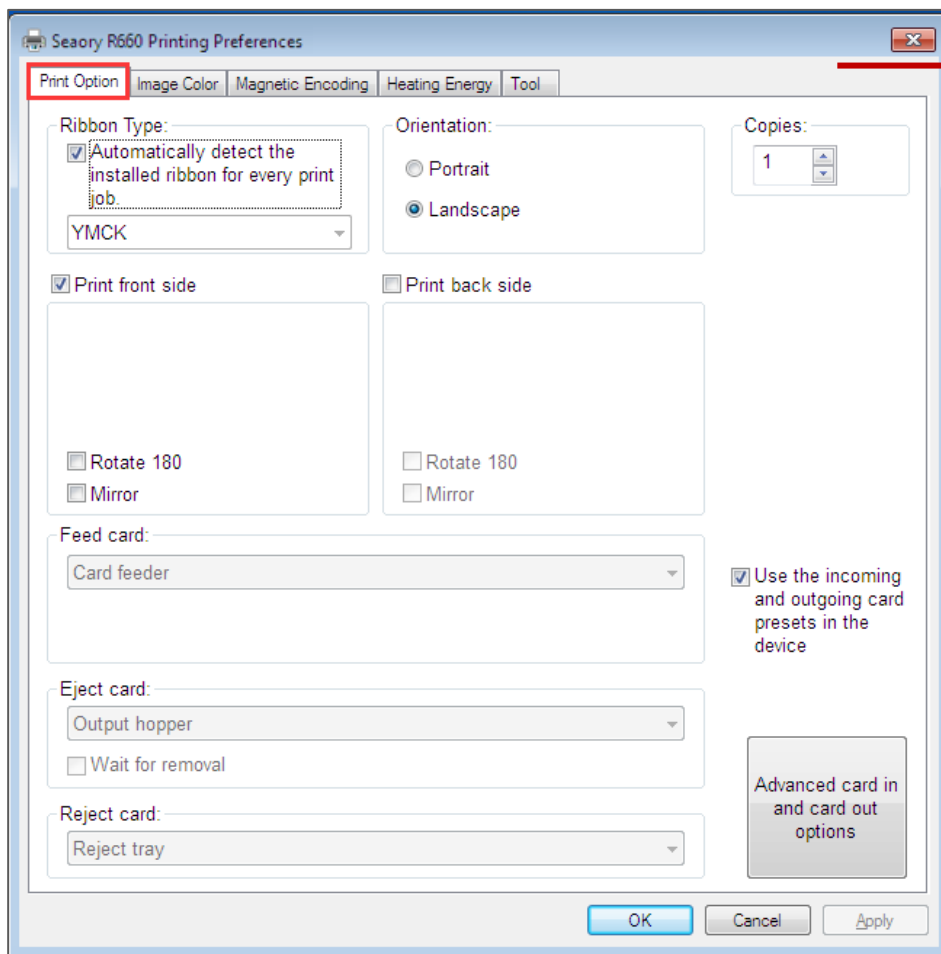

Printer preferences page

7.2 Ribbon Type Setting

(1) Automatically detect the installed ribbon for every print job is default chosen.

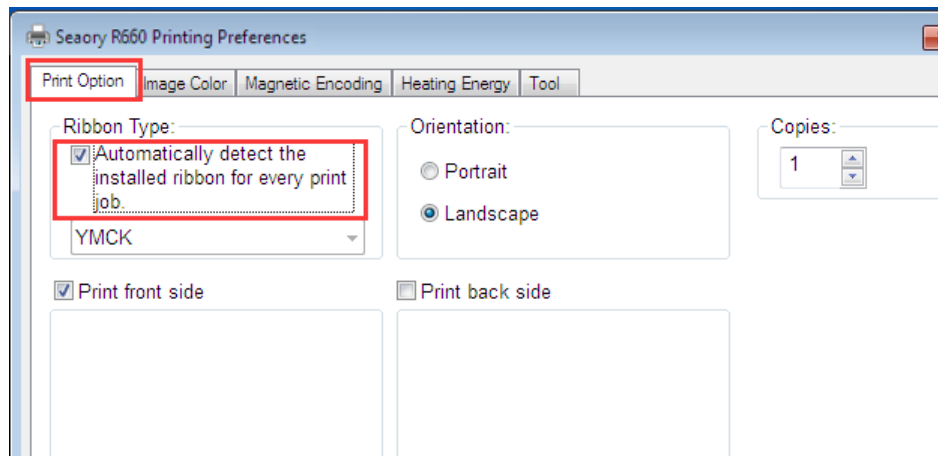

i Detect the installed ribbon is default option and suggest to keep it.

(2) When “Automatically detect the installed ribbon for every print job” was cancelled, the ribbon type needs to be set manually between below choices.

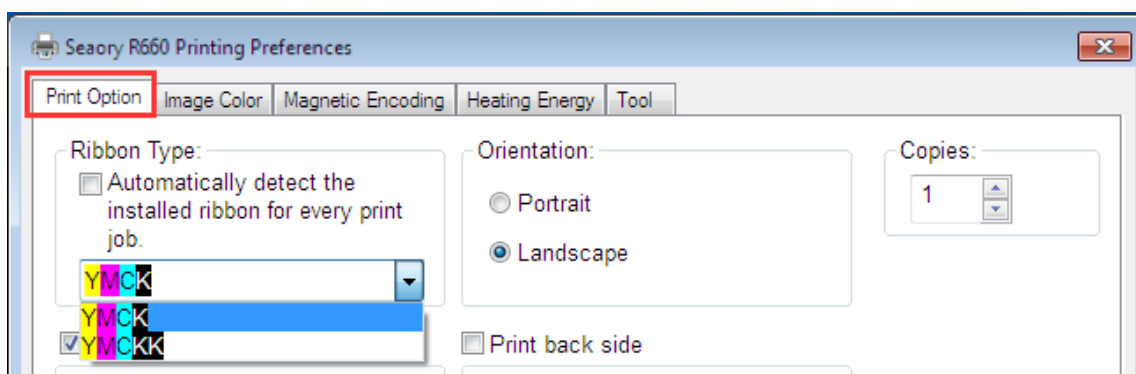

7.3 Printing Orientation Setting

(1) Portrait or landscape. Default selected landscape orientation.

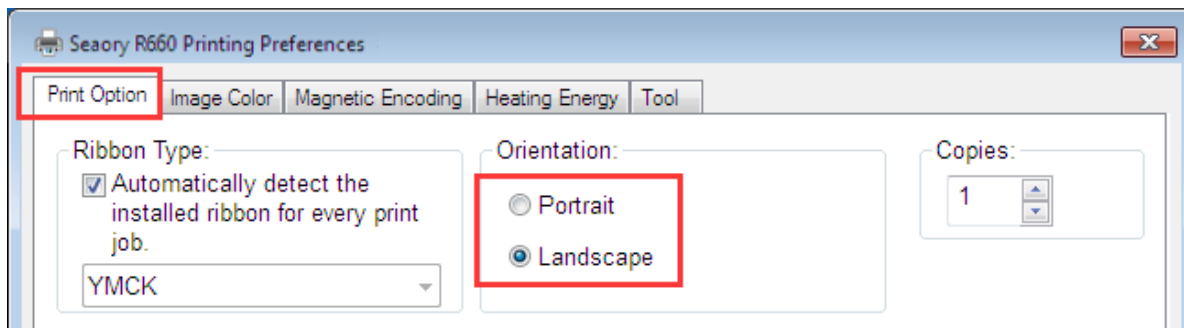

(2) Single or double side printing setting. Default only print front side, if need double-side printing, please also select print back side.

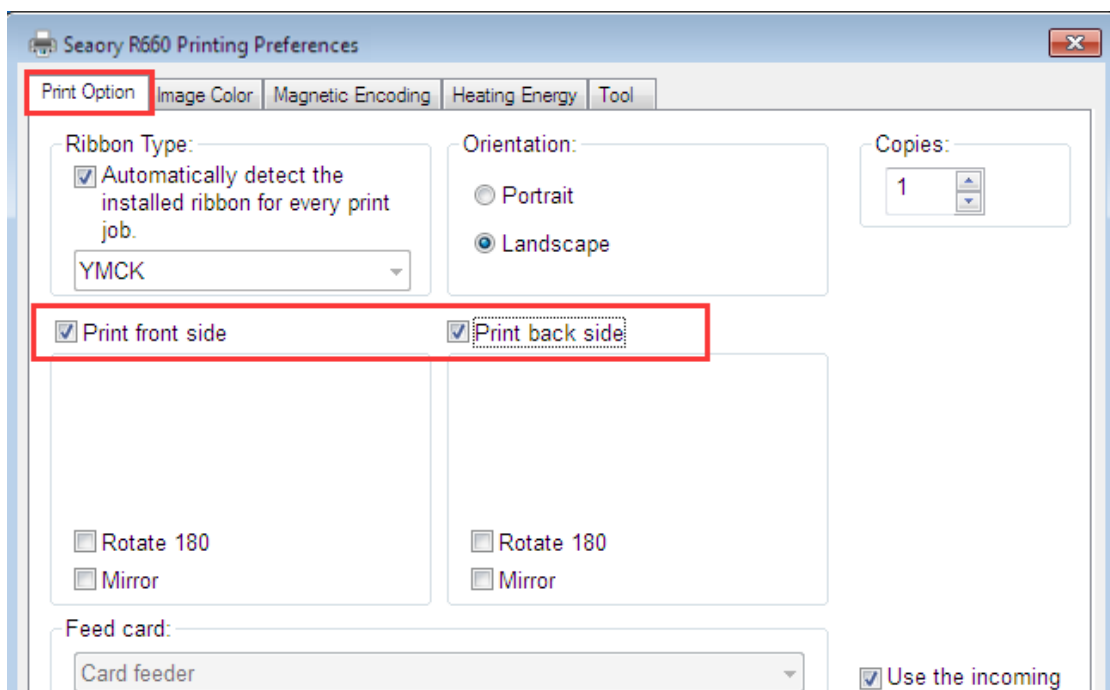

7.4 Printing Page Rotate Setting

Default not selected, if selected “rotate 180”, the printing page will rotary 180 degree.

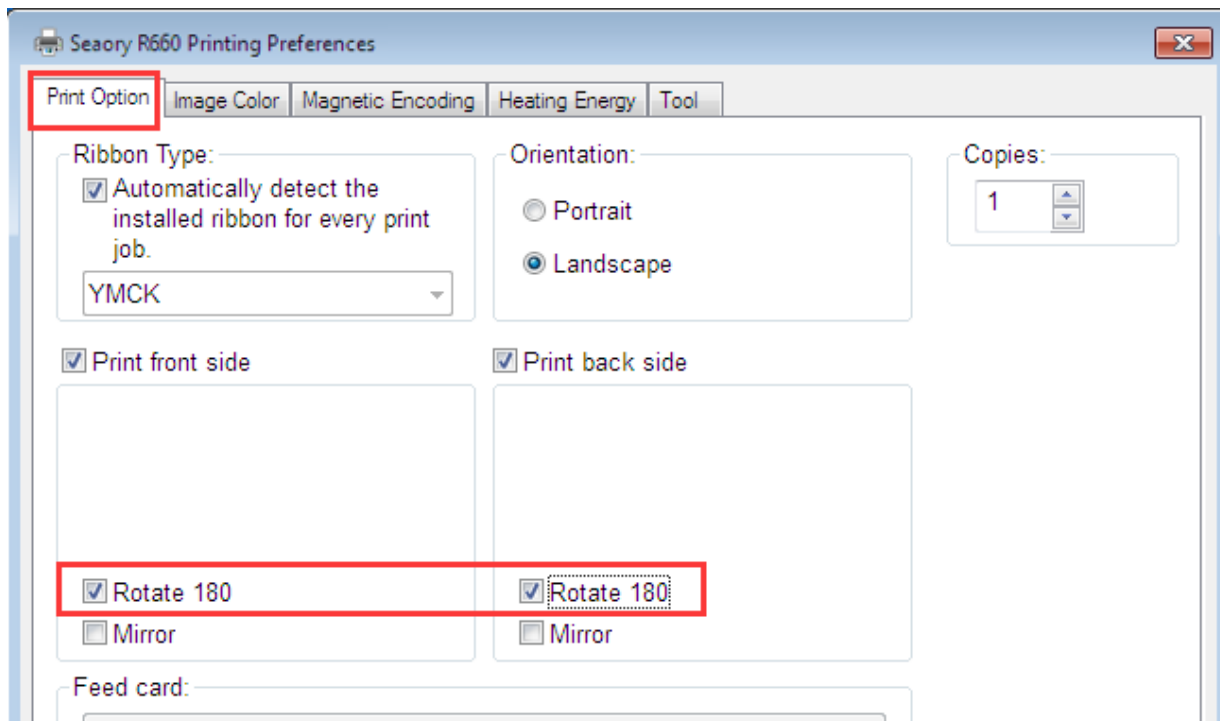

7.5 Feeding Card Mode Setting

When the card printer is ready, put the card into the card input/output port, and the machine will automatically swallow the card into the internal track of the device after detecting the card. For details on how to install the card (insert card), see 5.4.1 Front-end card input and 5.4.2 Back-end card input in this article.

(1) Front-end manual card input port: It means that when there is no card inside the device, the cards may enters into the internal track of the printer from the front-end manual card input port during printing.

(2) Back-end manual card input port: indicates that when there is no card inside the device, the cards may enters into the internal track of the printer from the back-end manual card input port during printing.

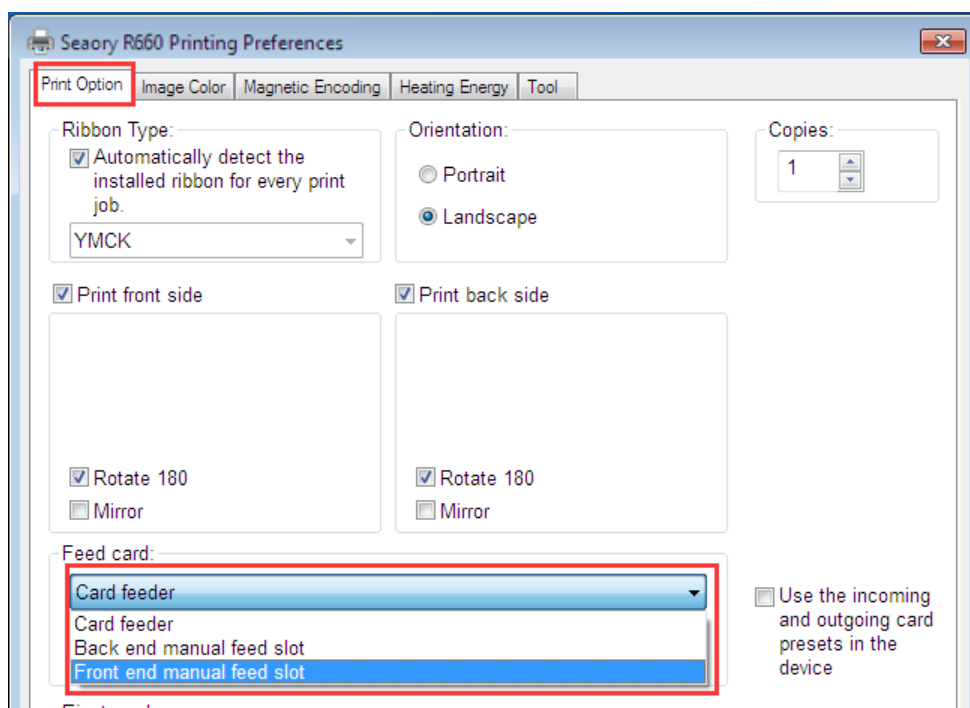

(3) Automatic card feeder: When installed into the card slot and the card needs to be fed from the front, it can be set to the automatic card feeder mode.

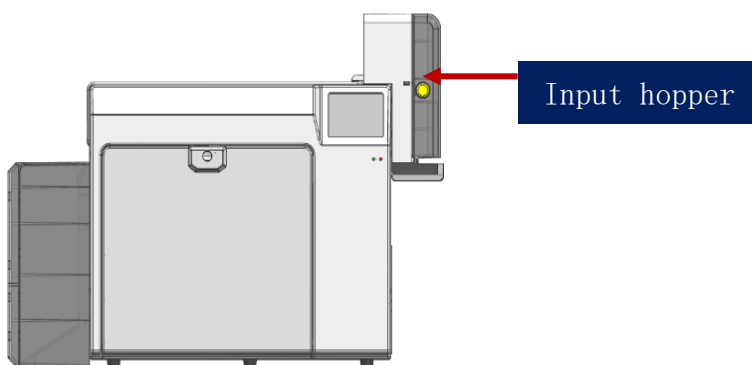

7.6 Setting of Card Output Mode

After the card is printed, select the card out method, you can choose the following 4 card out positions.

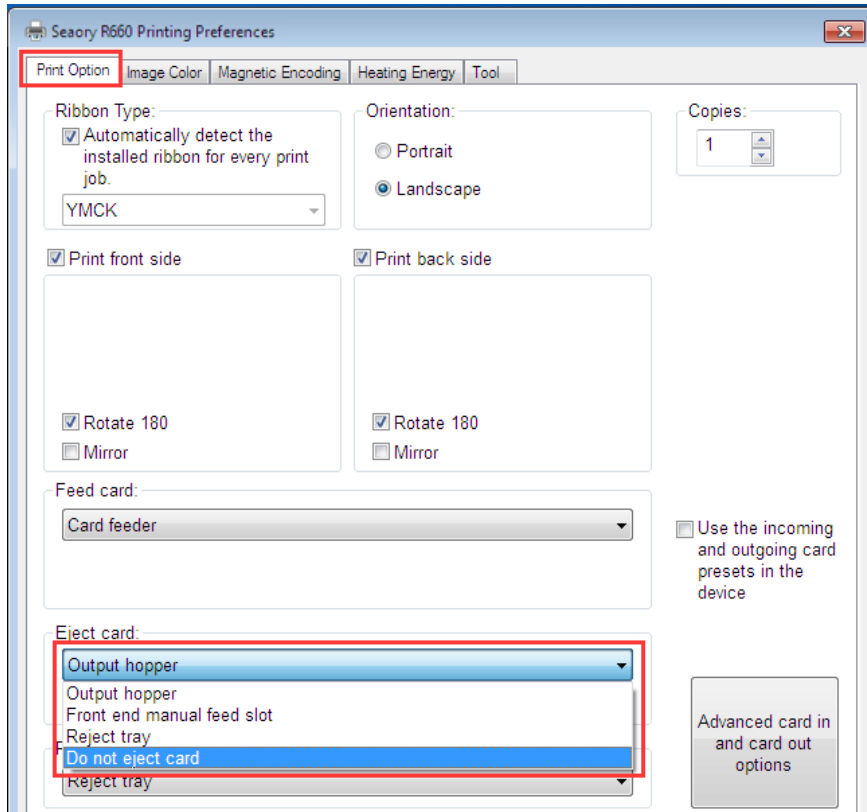

(1) Manual card output port at the back end: the card is ejected though this port after the card is printed.

(2) Manual card output port at the front end: the card is ejected though this port after the card is printed.

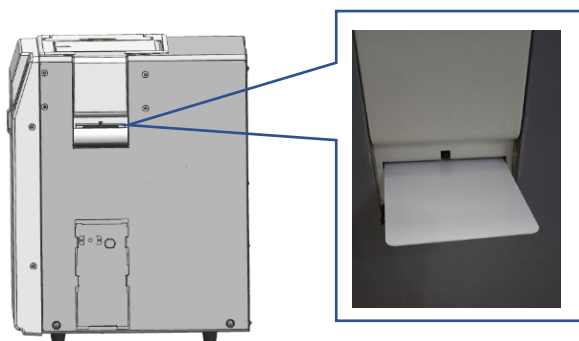

(3) Don't eject the card: It indicates that the card will stay on the card track of the printer after printing.

(4) Defective card box: It means that the card will fall into the defective card slot after printing is completed.

7.7 Defective Card Mode Settings

On the "Print Option" setting page in the printer preferences, you can unify the card out direction of the faulty card.

The default location of the defective card: the defective card slot. When the card is moved to the defective card slot, the card will be returned to the designated card slot according to this parameter setting.

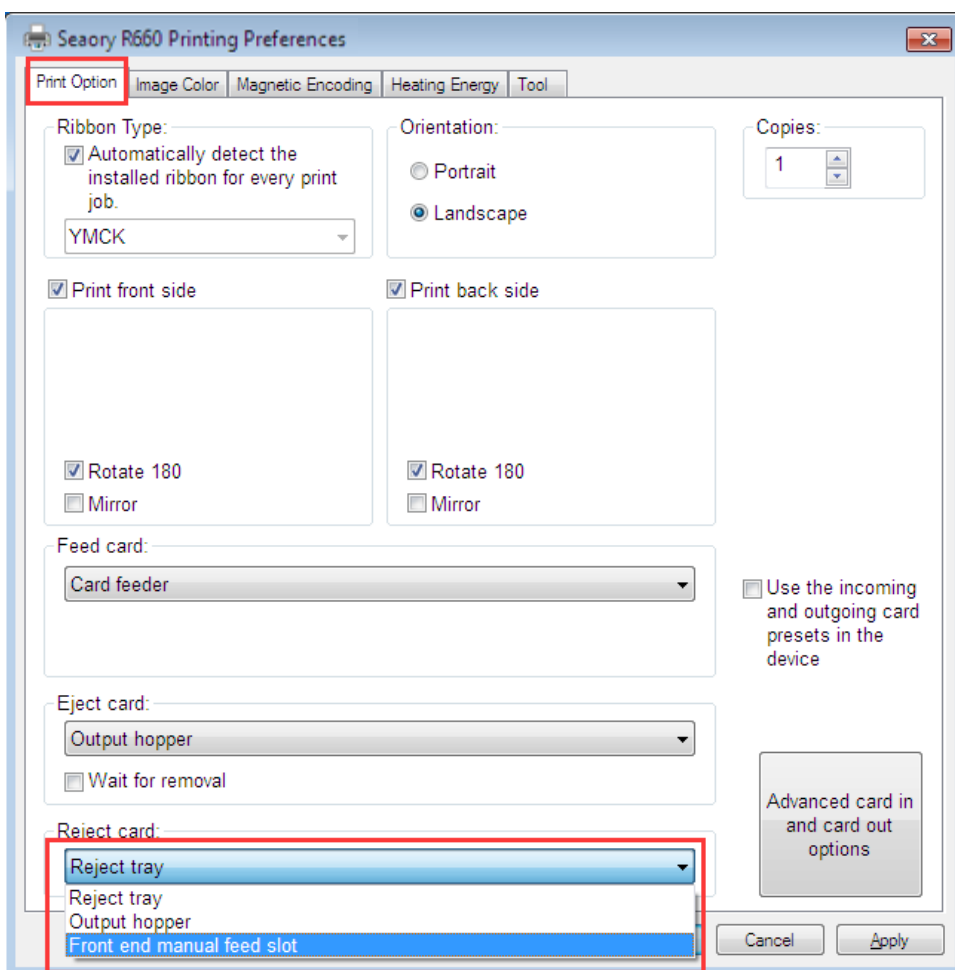

i Generally, reject card box will be used when reading and writing chip cards.

7.8 Image Color Settings

The driver default is optimal, normally it does not need to change, you can customize if you need.

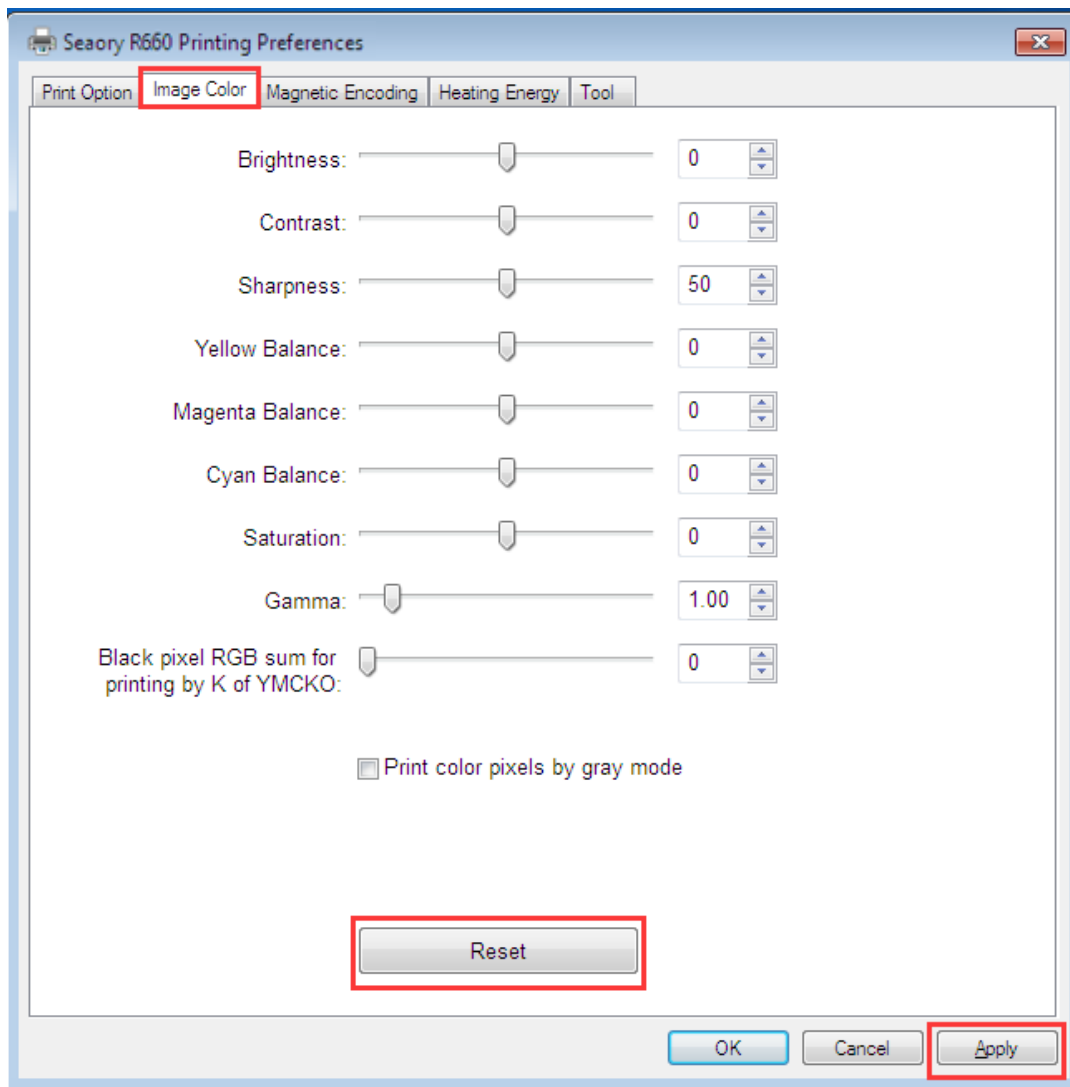

Reset: means restore factory default image color setting.

Apply: means after setting new parameter value, click “apply” to take effect.

7.9 Magnetic Encoding Setting

Function of Magnetic stripe encoding: Realize encoding process though setting filter characters by driver. For details, see the following pictures:

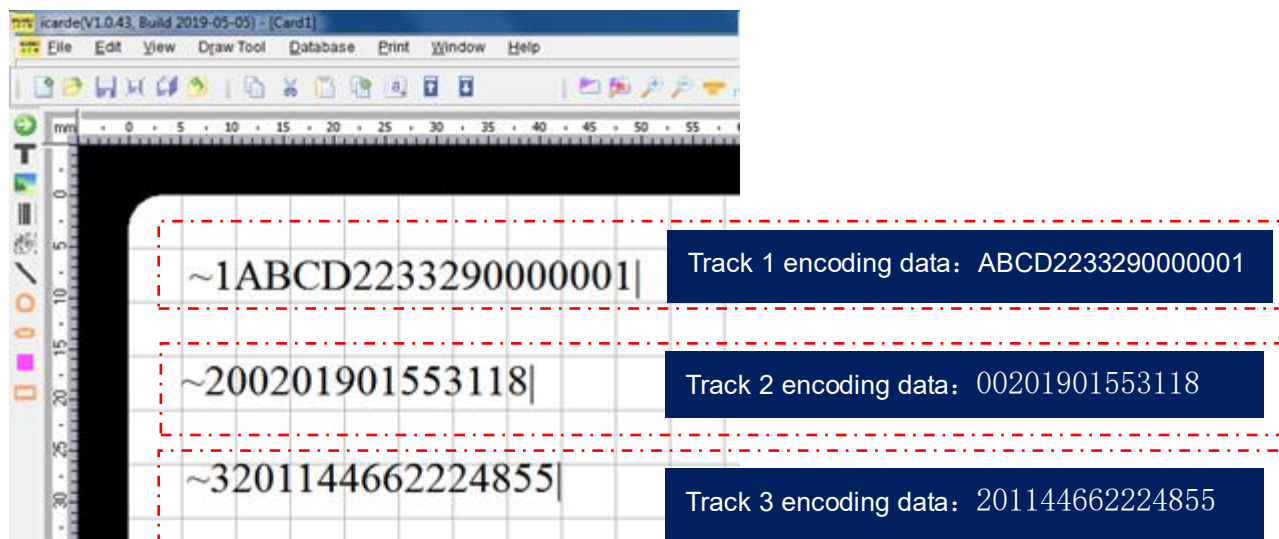
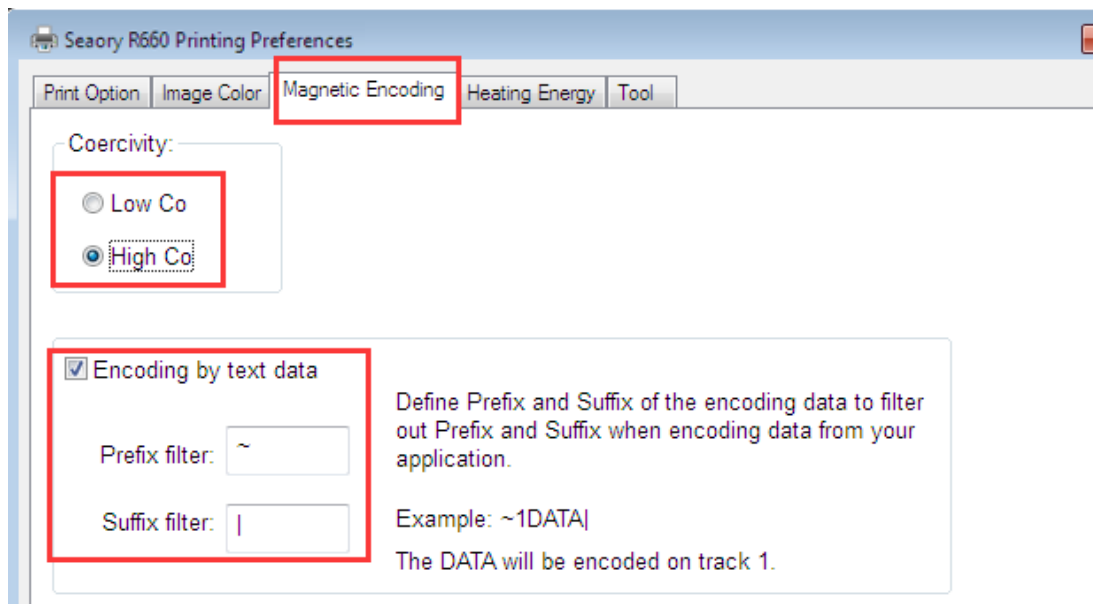

'~1' means track 1, '~2' means track 2, '~3' means track 3, and the '|' means stop code.

7.10 Heating Energy Setting

When the printing color is relatively light, it's necessary to increase the heating energy value. When the printing color is dark or ribbon is easy to break, the heating energy value need to be decreased.

The default value is the factory optimal value.

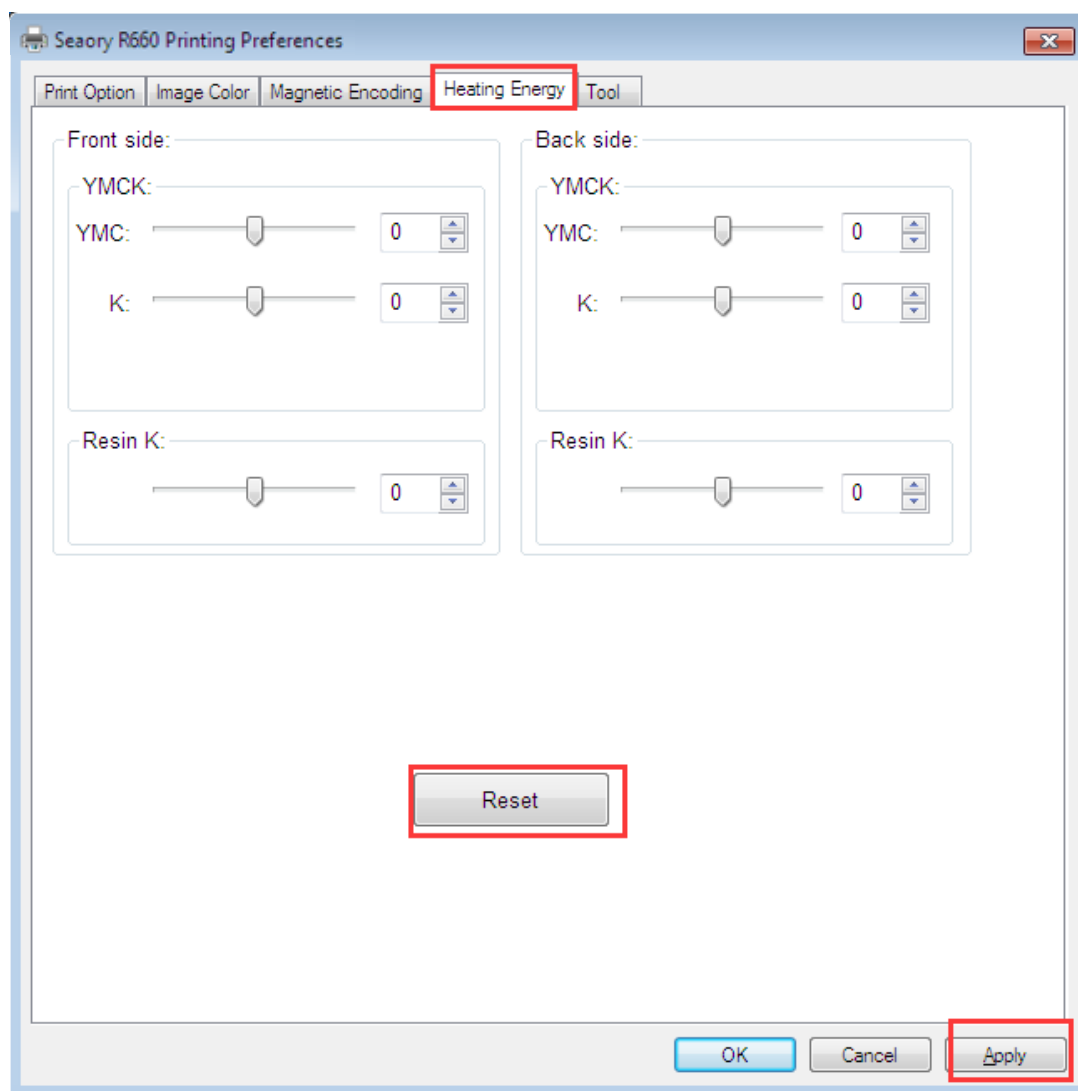

- YMCK is for YMCK ribbon
- Resin K is for monochrome ribbon
- Reset is to restore factory setting
- "Apply" is to adjust the new parameters to be effective

7.11 Tool Setting

Deposition of dust or contaminants inside the card printer may cause damage to important parts and affect the printing effect. Therefore, it's recommended to clean the printer when changing the ribbon or at least clean one time a month.

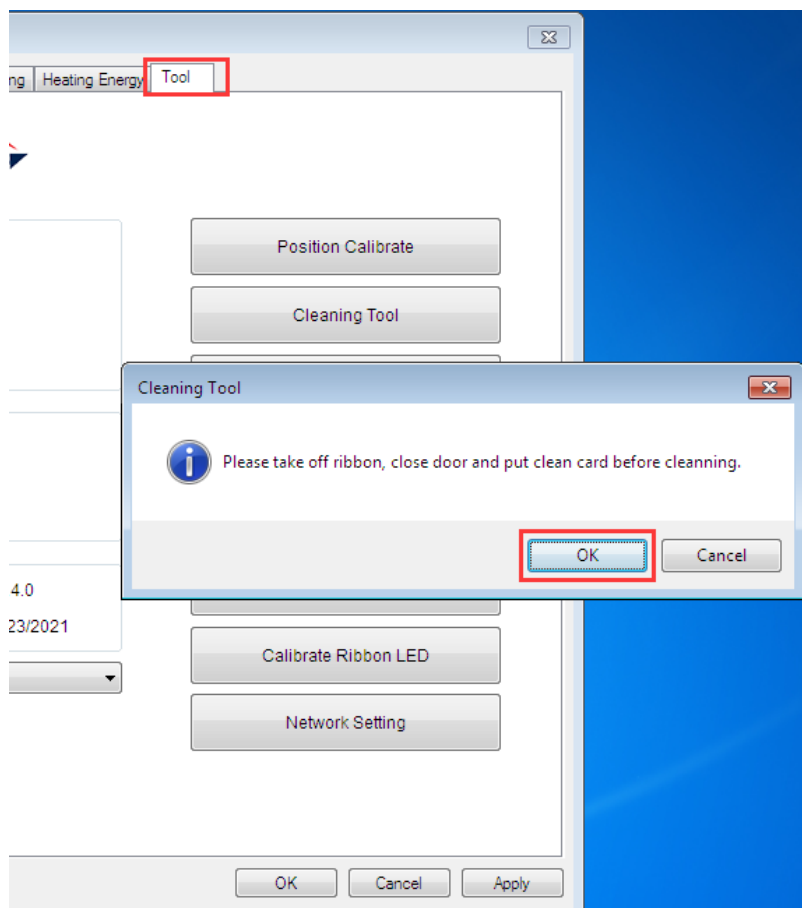

Cleaning steps according to the driver leads are as follows:

Step 1: Take out the cleaning card from the accessory box and remove the 3M hyaline layer on cleaning card's both sides.



Step 2: Open card printer upper cover, take out the ribbon cartridge and then close the upper cover.

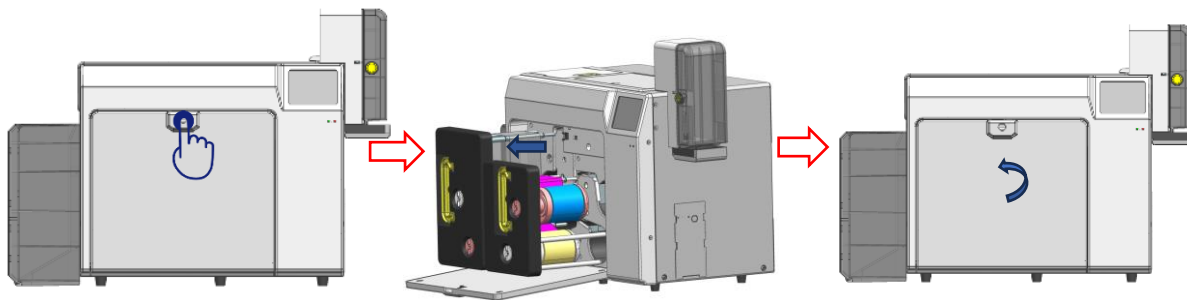

Step 3: Put the cleaning card into the input hopper

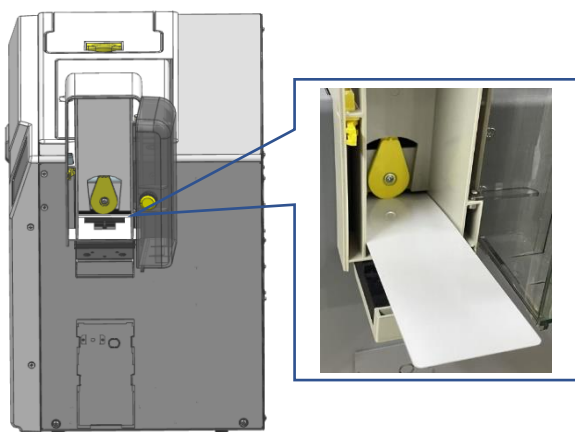

Step 4: Click “OK”. The card printer will start to clean itself.

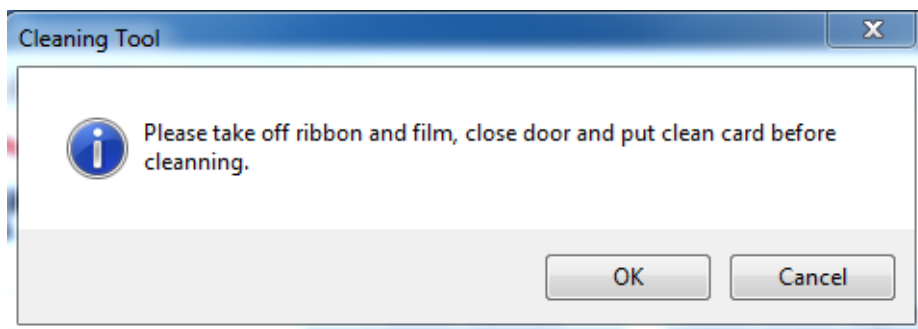

Step 5: After cleaning is completed, the printer can work normally after installing the consumable ribbon holder

7.12 Magnetic Stripe Tool

This function is mainly to test magnetic stripe card encoding.

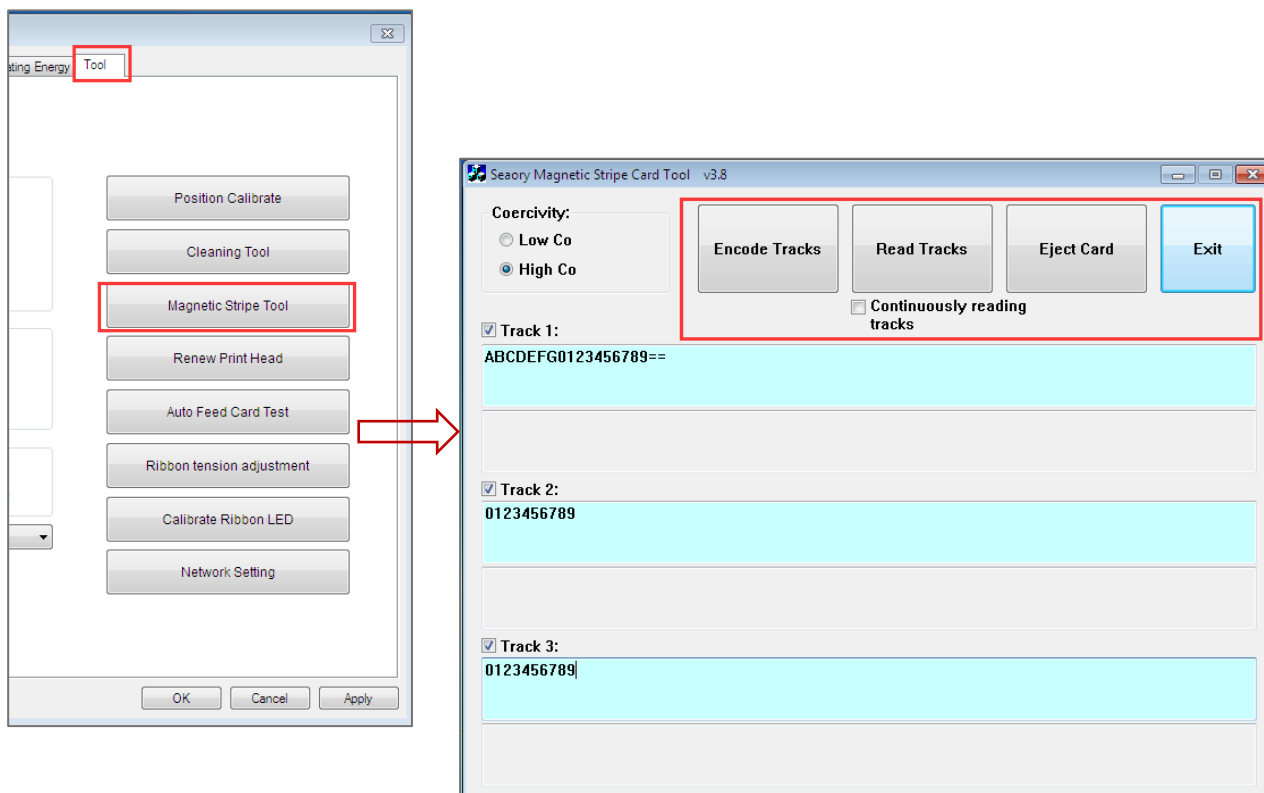

- Magnetic stripe encoding: To test magnetic stripe cards Encoding functions.
- Magnetic stripe reading: To test magnetic stripe cards Reading functions.
- Output card: The card moves to the card hopper.
- Exit: Close current tool interface.

7.13 Ribbon Tension Adjustment

Adjust the ribbon tension when printing appears "wrinkle". Generally, if there are wrinkles in the middle of the card, you need to reduce the red end tension. When there are wrinkles on the starting or ending edge of the card, increase the red end tension until adjusted to satisfied effect.

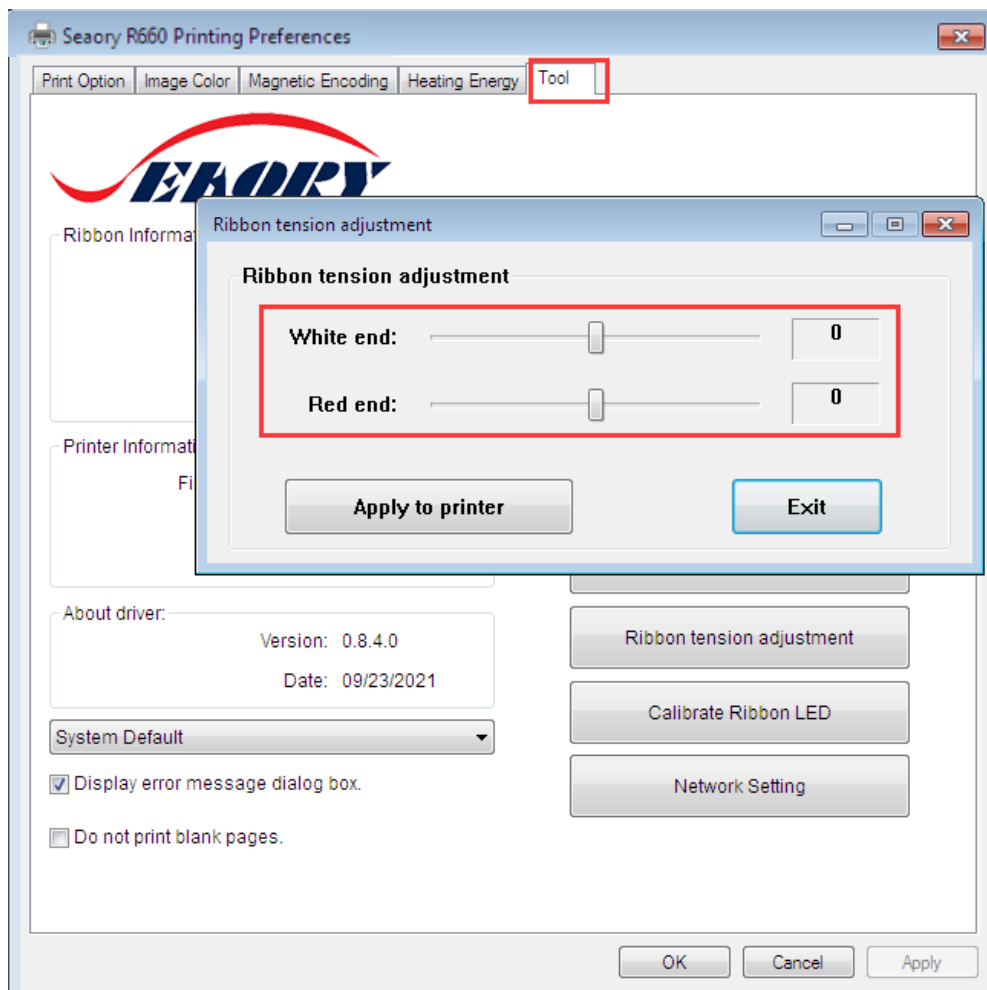

Apply to the card printer: it means that it will take effect after adjusting the tension parameter value.

7.14 Tool

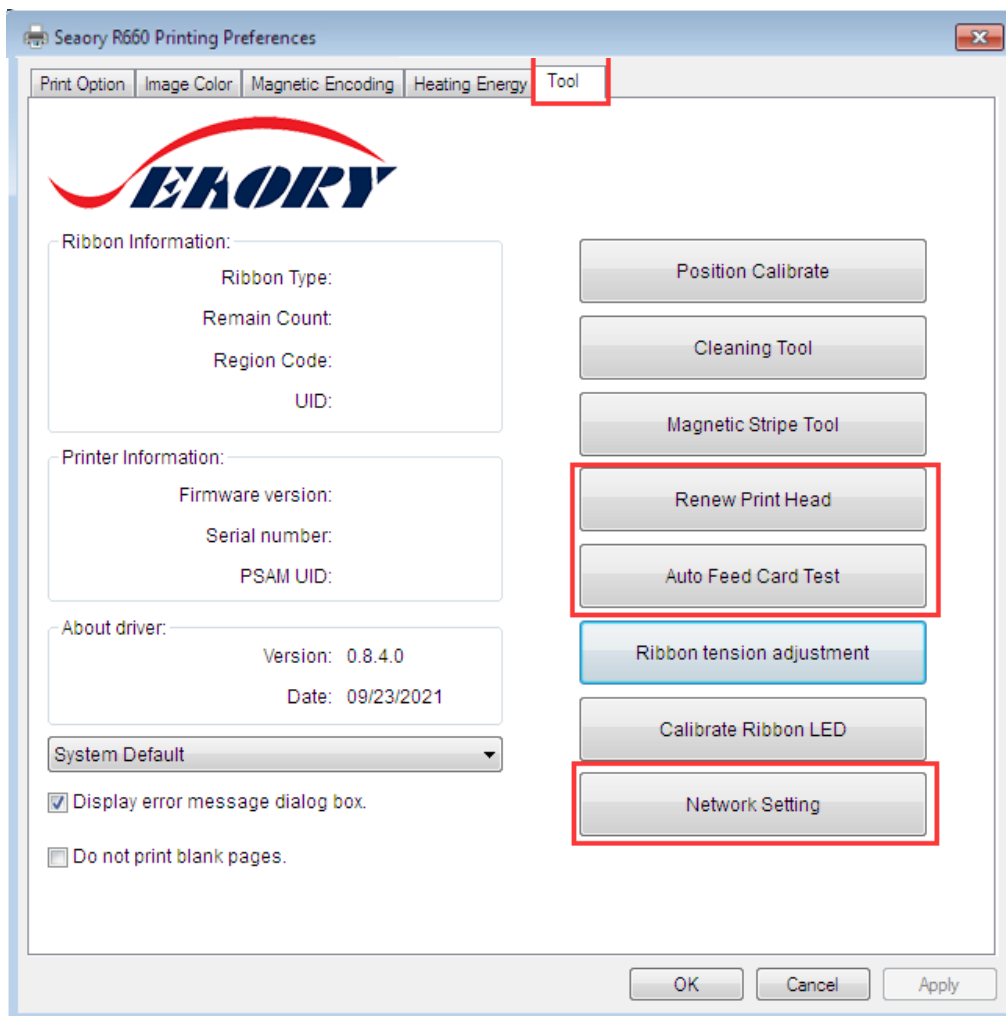

(1) Replace print head: please renew the barcode of new print head after replaced print head. Otherwise it may lead to print problem.

(2) Network setting: card printer IP information reference tool.

More details please check [6.4 section](#).

(3) Automatic card input testing tool(Auto Feed Card Test): verify the card can be feeding automatically.

8. Print Test

8.1 Driver Test Page

Step 1: In the list of printers and devices → right-click the Seaory R660 printer → printer properties

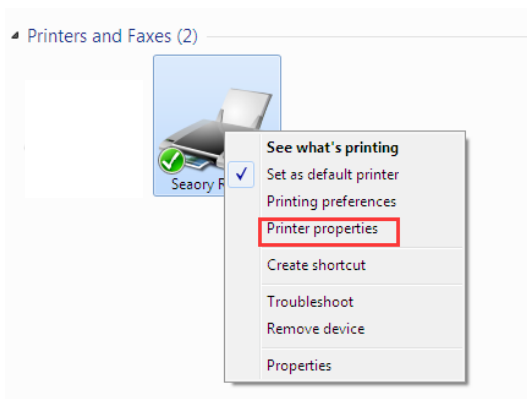

Step 2: Place some blank white cards into input hopper, then click” Print Test Chart”.

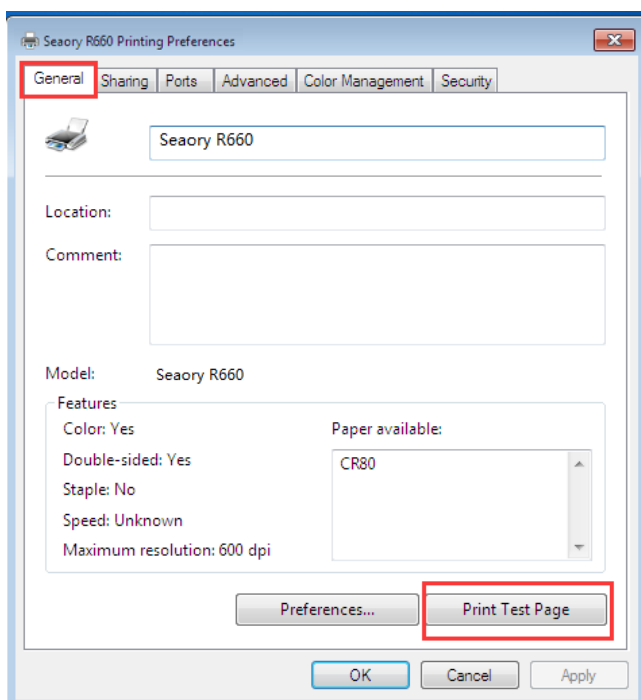

Step 3: Print out the following card, the surface driver and hardware installation are normal.



8.2 Seatory iCARDE Card Design Software

After all the above steps are completed, relevant software can be used to print and test the card printer. You can also do print test through Seatory's iCARDE software. For details, please refer to Seatory iCARDE manual.



9. Cleaning and Maintenance

9.1 Replace Cleaning Roller

The purpose of the cleaning roller is to absorb the dust on the card and improve the printing effect.

Replace cleaning roller after every roll of ribbon use up or one time per month. Operating details please refer to [5.1 section](#)

9.2 Cleaning Card Moving Path

Deposition of dust or contaminants inside the card printer may cause damage to important parts and affect the printing effect. Therefore, it's recommended to clean the printer when changing the ribbon or at least one time a month.

Driver operating guide please refer to [7.11 section](#).

9.3 Cleaning Print Head

Print head is the most important and valuable part of card printer. Like a car, it's a consumable product that will eventually breakdown. Only continuous attention to maintenance can extend its lifespan.

Maintenance method is to use the cleaning stick for cleaning. Please clean the print head every time you change the ribbon or printing effect is poor. And it's also recommended to clean the print head once a month.

Cleaning Print Head Steps:

Step 1: Take out cleaning stick from accessories box.



Step 2: Turn off the card printer, open the upper cover and find the print head show in below picture.

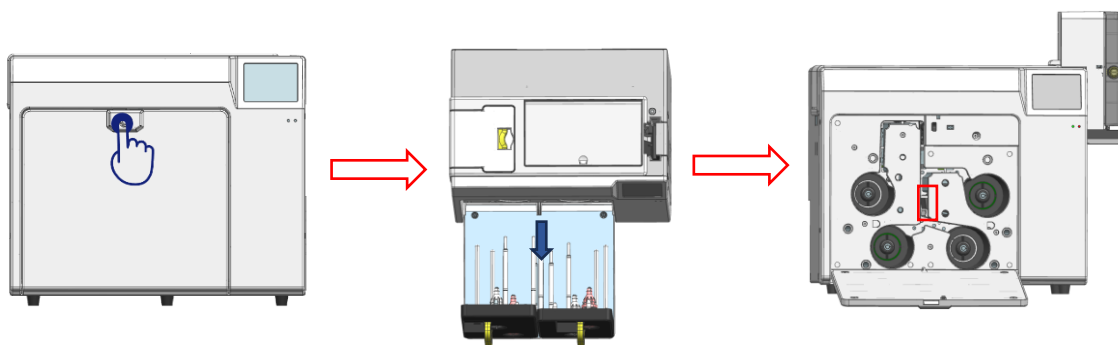

Step 3: Wipe the print head in one direction, from left to right or right to left with cleaning stick. Do not wipe back and forth. Generally wipe 3-5 times will be ok.

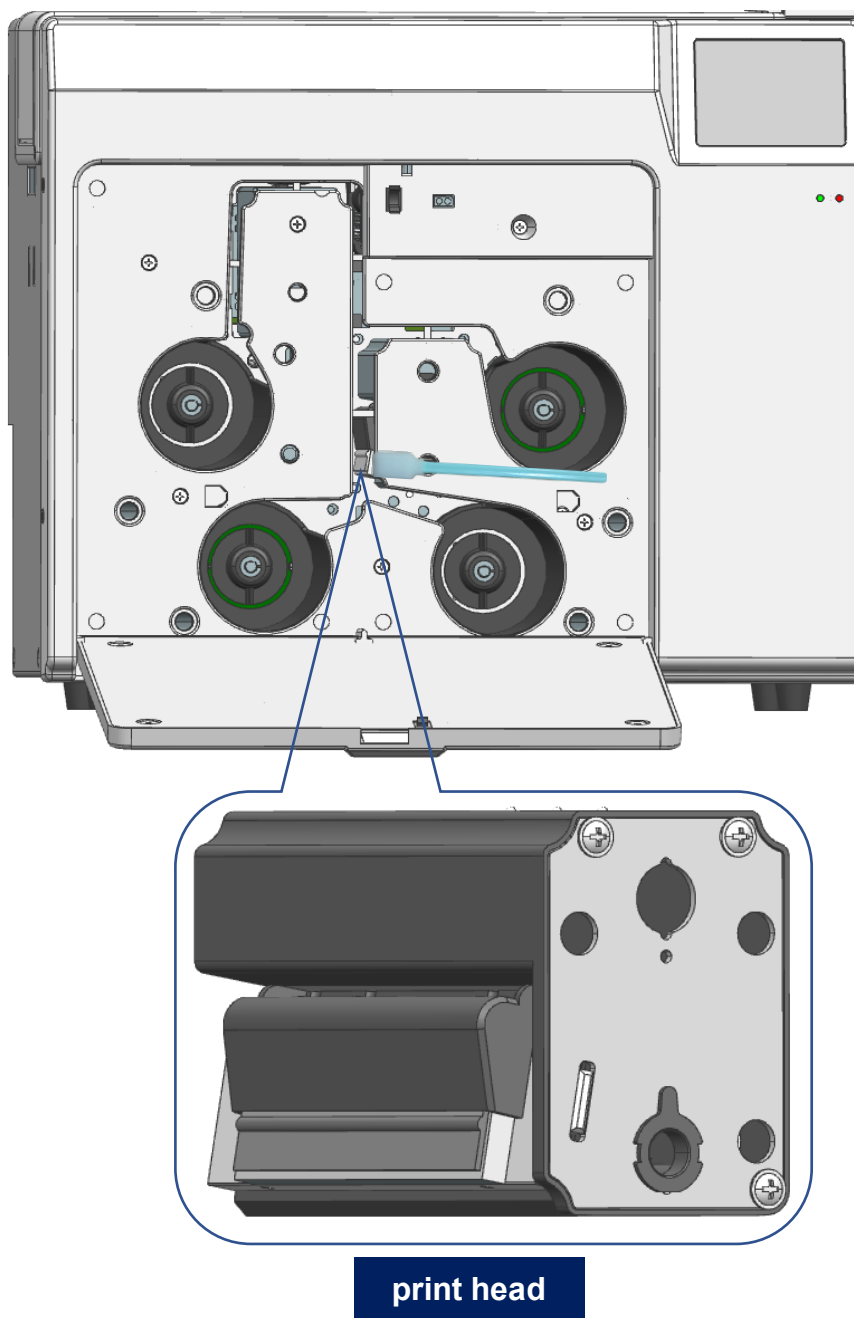

One-way wiping requirements: After wiping from the outside to the inside, the cleaning stick and cotton swab are required to leave the print head according to this figure. Avoid wiping back and forth to damage the print head.

 Avoid print head direct contact with metal objects, sharp objects or fingers, and do not contaminate any liquid to clean the print head.

10. Touch Screen Operation Instructions

This type of ID card printer is equipped with a 3.5-inch color touch screen, which allows users to operate more intuitively and conveniently

10.1 Main Interface Introduction

Printer ready status page, when the printer is in a waiting state.

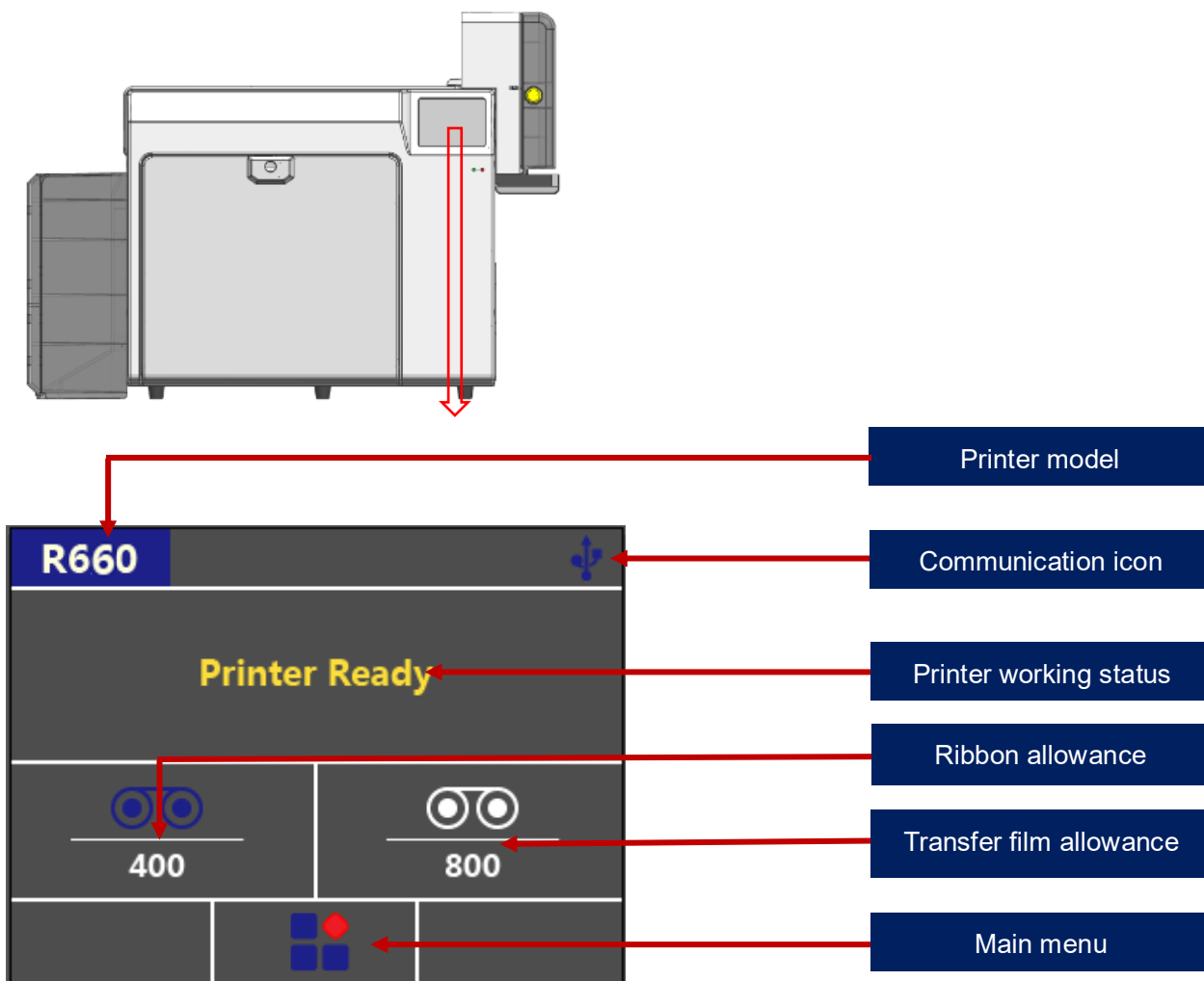

Ribbon allowance: The above figure shows that the ribbon margin is 400 as shown, which means that the remaining ribbon can print 400 cards (single-sided).

Transfer film allowance: The ribbon allowance is 800 as shown, which means that the remaining transfer film can print 400 cards (single-sided).

10.2 Menu

Touch and click the menu icon in the display interface as shown in the red frame in the picture below to switch to the menu interface in the picture on the right.

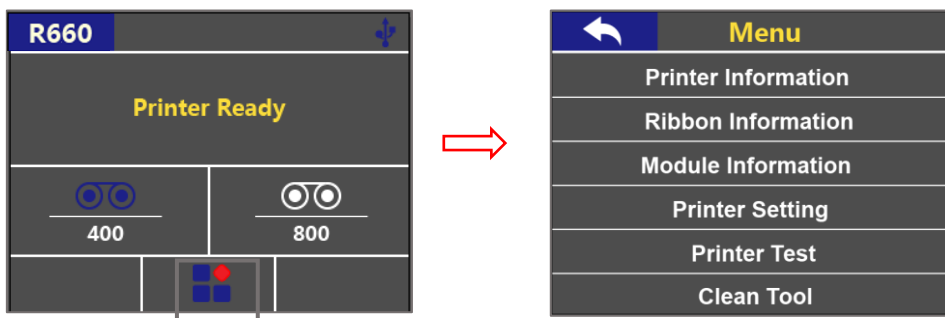

10.2.1 Printer Information

You can check the basic information of the printer: model, code type, firmware version, serial number, and print quantity by touching and clicking on the "printer information" in the red box in the picture below.

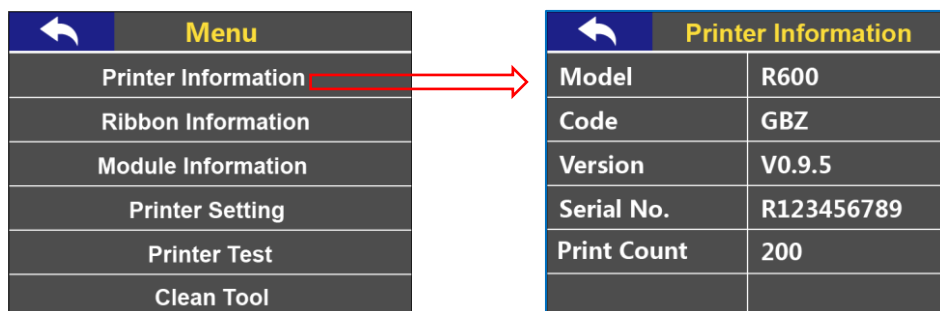

10.2.3 Ribbon Information

You can check the basic information of the ribbon and transfer film by touching the red box "ribbon information" in the picture below: ribbon type, quantity, code type, serial number, transfer film quantity, transfer film serial number. Convenient for users to more intuitively understand the usage status of consumables.

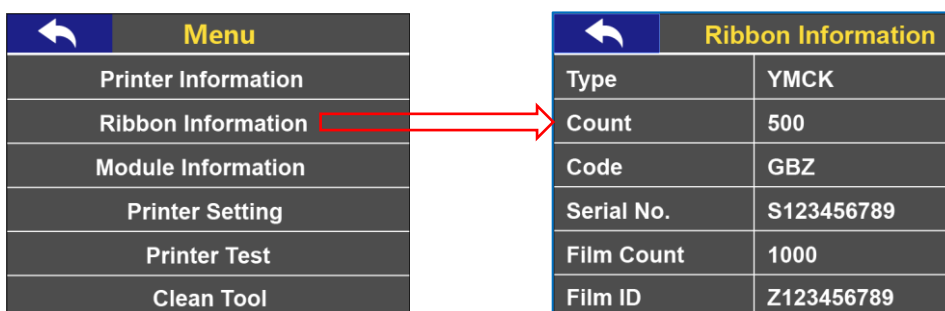

10.2.4 Module Information

Clicking on the "Module Information" in the red box in the picture below, you can understand the installation and function status of the multifunctional optional module.

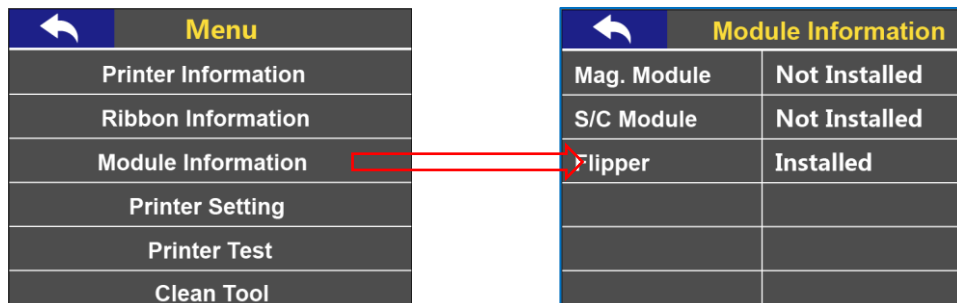

10.2.5 Printer Settings

You can quickly switch the display interface language, network parameter settings, and buzzer switch by clicking on the red box "Printer Settings" in the picture below.

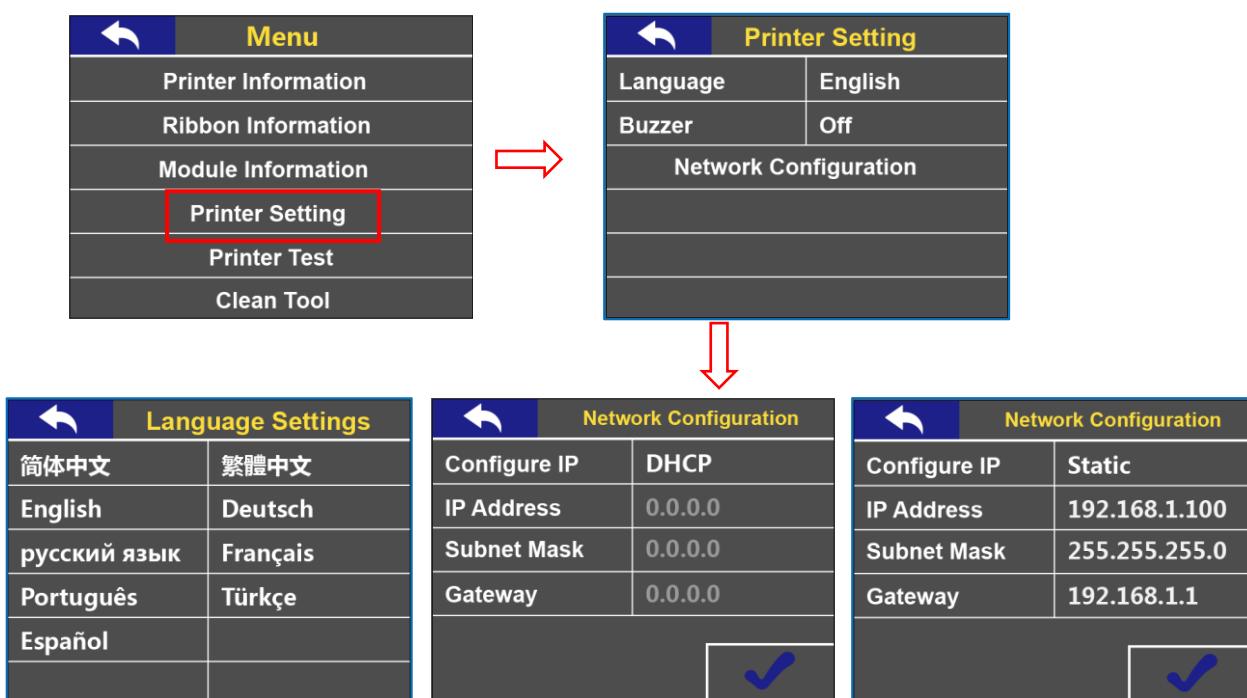

When the Ethernet interface (RJ45 network interface) is selected as the communication method of the printer, the network parameters can be set on the display screen. You can also choose DHCP to automatically obtain network parameters.

10.2.6 Printer Test

You can test the printing function and magnetic stripe function of the printer by clicking "Printer Test" in the red box in the picture below.

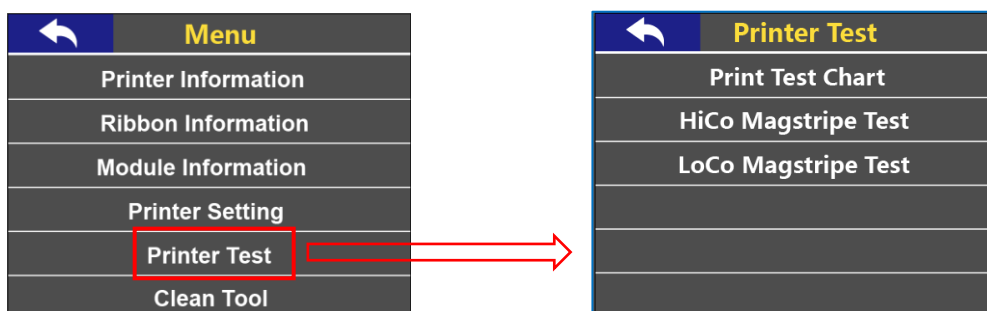

Before performing the test, please refer to Chapter 5.6 Install Cards and Place Counterweight Cards to install cards and insert cards according to the chapter of this article.

- There is no requirement for the direction of contactless IC cards and ordinary white cards, the card insertion direction can be customized according to needs.
- ISO7811 standard magnetic stripe card should be inserted strictly in accordance with the card direction in the picture below, which is consistent with the ATM card insertion rules. If you only need to print and don't need to encode chip data, there is no requirement for the direction of the card. The card insertion direction can be customized according to needs.

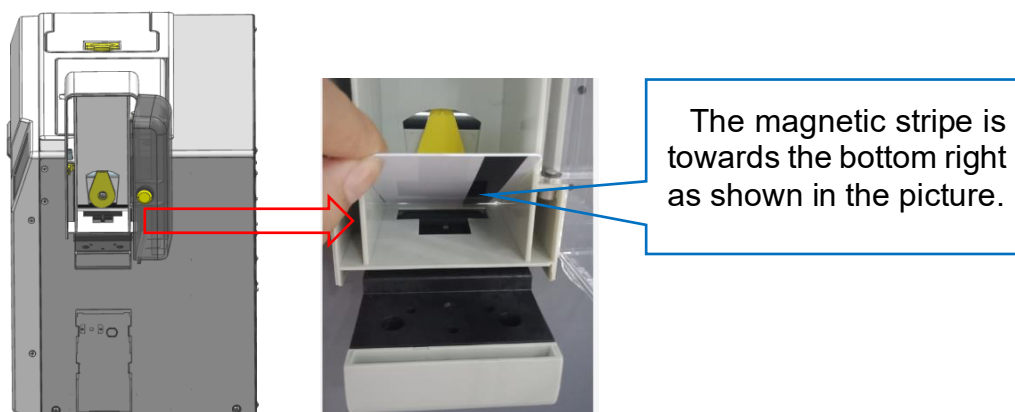

10.2.7 Cleaning Tool

You can test the printing function and magnetic stripe function of the printer by clicking on the "cleaning tool" in the red box in the picture below.

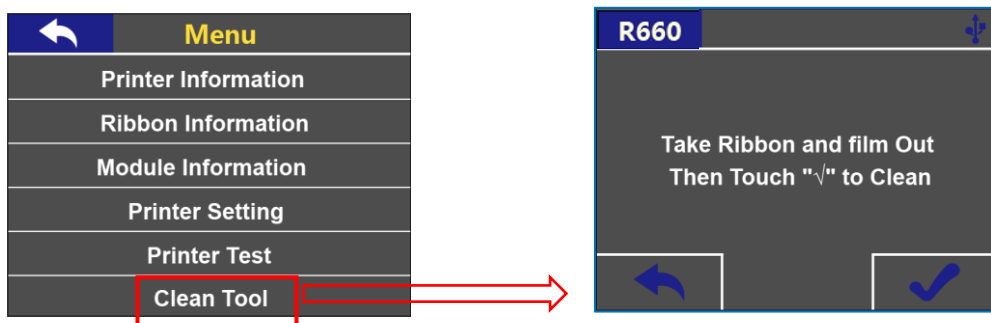

Before performing cleaning, please follow the instructions on the page or refer to Chapter [7.11 Cleaning Tool](#) of this article for preparations.

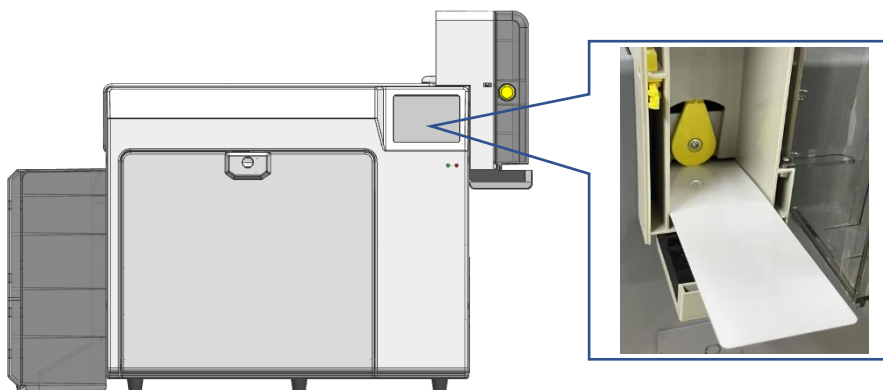

Dust or pollutants deposited inside the printer during use may cause damage to important parts and affect the printing effect. Therefore, it is recommended to clean the ribbon it every time or at least once a month.

11. Common Fault Codes and Solutions

11.1 No Action Occurred

- Check if the card printer driver is installed correctly
- Check the power supply and USB cable connector
- Check the ribbon and cards
- Print test picture

11.2 Blank White Card Printed

- Check the ribbon
- Please go to the card printer driver to reset the parameters ('Preferences'-'Tool'-'Position Calibrate'-'Reset to Factory Default') or adjust the L T S value
- Try to print after adjustment
- Please check whether the card used meets the specifications of CR-80

11.3 Partial or Wrong Printing

- Check the printer settings
- Check the cable and ribbon
- Confirm that the cleaning roller is clean
- Check if the card is clean
- Check the print head

11.4 Printing Defects

- The surface of the card may be contaminated
- Please use the cleaning card for cleaning
- The print head is contaminated or damaged and needs to be wiped clean
- Check whether the cleaning wheel needs to be replaced

11.5 White Horizontal Lines Appear in the Print

- Check if the ribbon is installed correctly
- Check if the print head is contaminated or damaged

11.6 White Vertical Lines or Color Lines Appear in the Print

- The print head may be damaged

11.7 Blurred Image in Printing

- Check if the ribbon is installed correctly
- Check if the cleaning roller or print head is contaminated
- Check if the card specifications meet the requirements