



Desktop Single-sided Card Printer

Operation Instruction



Model: Seatory S26

Shenzhen Seatory Technology Co., Ltd.

*Excellent quality
Perfect service*

Statement

● Copyright

Copyright© Shenzhen Seaory Technology Co.,Ltd. All rights reserved.

Users shall respect the latest regulations on copyright of their own countries. This manual, no matter in E-file, text version, or other formats, can never be partially or totally copied, translated or spread in any way for any reason, without the writing authorization from Shenzhen Seaory Technology Co., Ltd. Please forgive that any change of this manual will not be further noticed. Shenzhen Seaory Technology Co., Ltd. shall take no responsibility for any errors (if any) in this manual, accidental damage of printer, or losses caused by this manual contents.

All the pictures and specifications in this manual are made to help description, while the actual specifications shall be subject to order. If any query, please refer to the products specifications on the website of Shenzhen Seaory Technology Co., Ltd.

● Warranty

With respect to warranty conditions and restrictive clauses, please refer to the Warranty Card enclosed in the printer package. Thanks for choosing Seaory S Series card printer, to start a successful cooperation between us. A variety of high quality personalization of identification cards, visa cards, and membership cards etc. can be realized through simply operation of these card printers. You shall make sure that printer consumables you bought are from original manufacturer. To know more information, please visit our website: www.seaory.com. If any errors found, please let us know by mailing to: info@seaory.com.

● Description of model difference

The differences between Seaory S26 and S26X(X=A-Z) are only for model naming, screen printing and special code type. The basic hardware and software are exactly the same. Therefore, only the pictures and model names of Seaory S26 are included in this Manual.

● Sign Indicates





Special Warning Message



More In-depth Information Notice

● Warning Sign

	<p>Label meaning: The equipment with the label is only designed and evaluated according to the altitude of 2000m. Therefore, it is only applicable to the safety application below the altitude of 2000m. When used above the altitude of 2000m, there may be safety risks.</p>
	<p>Label meaning: The equipment with the logo is only designed and evaluated in accordance with the non-tropical climatic conditions. Therefore, it is only suitable for safe use in non-tropical climatic conditions. When used in tropical climatic conditions, there may be safety risks.</p>

This is a Class A product. In a domestic environment this product may cause radio interference in which case the user may be required to take adequate measures.

Catalogue

1. Product features1	7.6 Eject card setting26
1.1 Main function1	7.7 Reject card setting26
1.2 Features1	7.8 Advanced card in and card out options setting 27
2. Product parameter1	7.9 Image color setting28
3. Product introduction2	7.10 Print area setting29
3.1 Product Size2	7.11 Magnetic encoding setting31
3.2 Roof3	7.12 Heating energy setting32
3.3 Front-end4	7.13 Tool setting33
3.4 Back-end5	7.14 Position calibrate34
3.5 Bottom5	7.15 Cleaning tool35
3.6 Internal structures6	7.16 Magnetic stripe tool36
4. Accessories included7	7.17 Ribbon tension adjustment37
4.1 Open-case inspection7	7.18 Other tools38
4.2 Accessories list7	8. Print test39
5. Installation and usage8	8.1 Driver test page39
5.1 Install cleaning roller8	8.2 Seaory iCARDE card design software .40
5.2 Install ribbon9	9. Cleaning and maintenance40
5.3 Adjust the feed card thickness10	9.1 Replace cleaning roller40
5.4 Place the card, Add the weight module 11	9.2 Cleaning card moving path40
5.5 Install output hopper12	9.3 Cleaning print head43
5.6 Wiring installation13	10. Replace print head44
6. Driver installation15	11. Common fault codes and Solutions49
6.1 Operation system15	12. FAQ50
6.2 Notice before installation15	12.1 When card print no action50
6.3 Driver installation steps (USB communication interface)16	12.2 When print out the blank card50
6.4 Network setting18	12.3 When partial or error printing50
6.5 Driver installation (Ethernet communication interface)20	12.4 When the printed card has a defect50
7. Driver setting22	12.5 When the printed card appears white line 50
7.1 Printing preferences22	12.6 When the printed card appears white vertical or color lines51
7.2 Ribbon type setting23	12.7 When the printed card appears blurry image 51
7.3 Printing orientation setting24	
7.4 Printing page rotate setting24	
7.5 Feeding card mode setting24	

1. Product features

1.1 Main function

- A. Single-sided printing
- B. Automatic batch feeding
- C. Front-end manual feeding or card out
- D. Back-end manual feeding or card out
- E. Card holding, timeout automatic recovery
- F. Optional Modules
 - ① Dual interface card encoding module
 - ② Contactless ID card encoding module
 - ③ UHF chip card encoding module
 - ④ Magnetic stripe card encoding module
- G. Support full panel YMCKO ribbon, half-panel 1/2 ymckO ribbon, Single colors ribbons (Black, White, Red, Blue, Gold, Silver)

1.2 Features

- A. Adopt high resolution dye sublimation(direct-to-card) print method
- B. Continuous card printing ability, save time and labor cost
- C. Easy and user-friendly operation
- D. Light body, easy maintenance
- E. Low noise
- F. High printing speed
- G. Alarm for no card and alarm for full load of reject slot

2. Product parameter

Product Name	Seaory S26 desktop single-sided card printer
Print Method	Dye sublimation (Direct-to-card)
Power Supply	AC 100~240V, 50/60 Hz DC 24-25.5V, 2.7 A
Print Dimension	ISO CR80 (53.98mm×85.60mm) edge-to-edge printing
Print Resolution	300dpi × 300dpi , 300dpi × 600dpi , 300dpi × 1200dpi
Print Speed	Monochrome printing: 3-5s per card (single-sided) Full-color (YMCKO) printing: 18s per card (single-sided)

Card Material	PVC / composite PVC / other material upon request and validation
Card Thickness	0.3-1.05mm
Memory	128M
Input hopper capacity	100 cards (Standard 0.76mm thickness)
Output hopper capacity	50 cards (Standard 0.76mm thickness)
Operation system	Driver support: Windows XP/7/8/10, Windows Server 2003/2008/2012/2016, Linux,
LCM Display	Chinese: 8 characters per line, 2 lines English: 16 characters per line, 4 lines Support multi-language
Operating condition	Regular running temp.: 15°C-30°C (59-86°F), 20%-65%, RH non-condensing Lowest / Highest running temp.: 0°C(32°F)/40°C(104°F), 20%-65% RH non-condensing
Storage condition	Temp.: -5°C-70°C (23-158°F), 20%-70% RH non-condensing

3. Product introduction

3.1 Product Size

S26 card printer size : 450mm(L)×174mm(W) ×228mm(H) ,Net weight : 3.9Kg

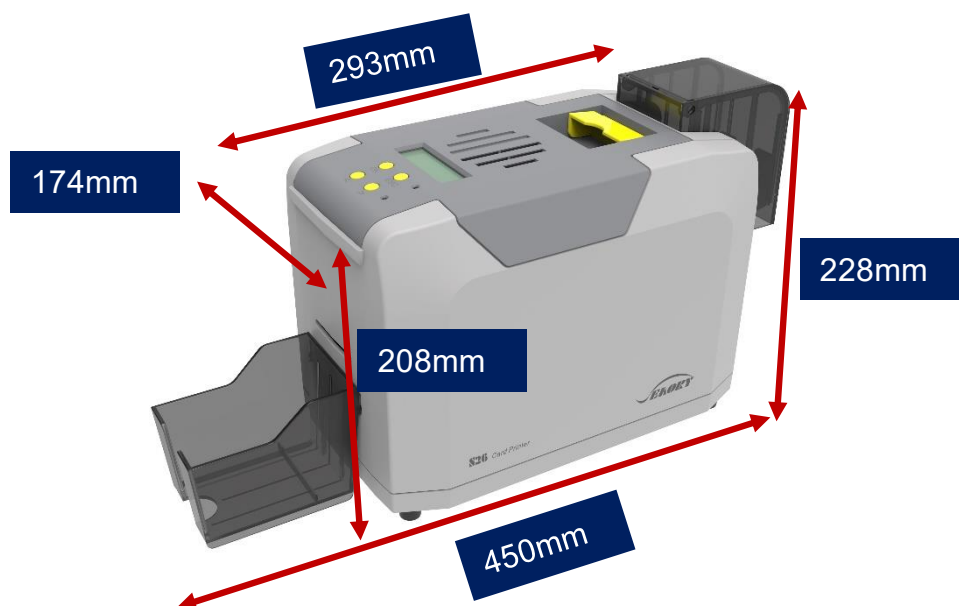

3.2 Roof

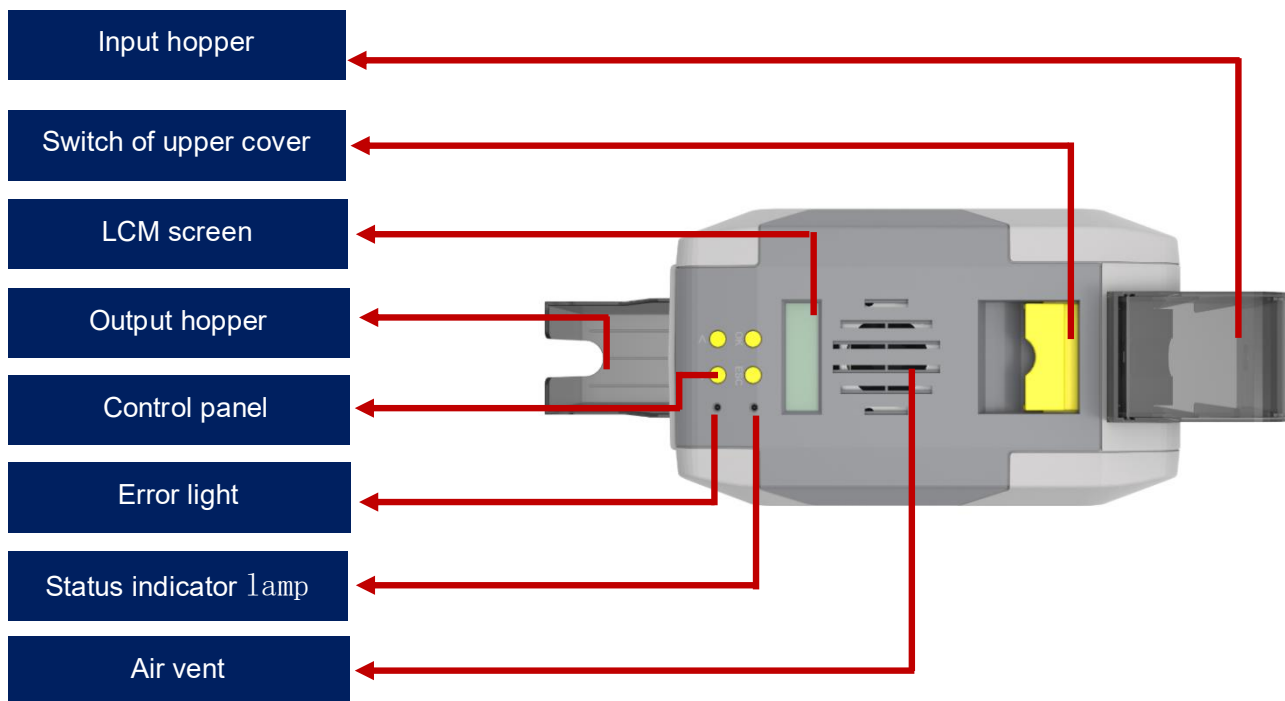

Main function description:

- (1) Input hopper: Blank cards storage place ,100pcs 0.76mm PVC cards input capacity.
- (2) Output hopper: Printed cards storage place, 50pcs 0.76mm PVC cards input capacity.
- (3) Switch of upper cover: Lift this switch to open the cover.
- (4) Control panel buttons: Query and set card printer parameters.
- (5) LCM Screen: Display card printer parameters and status.
- (6) Air vent: Release the heat generates by card printer and print head.
- (7) Error light: Turns to red when the card printer is not ready or failure.
- (8) Status indicator lamp: Green light indicate the card printer is working normally.

3.3 Front-end

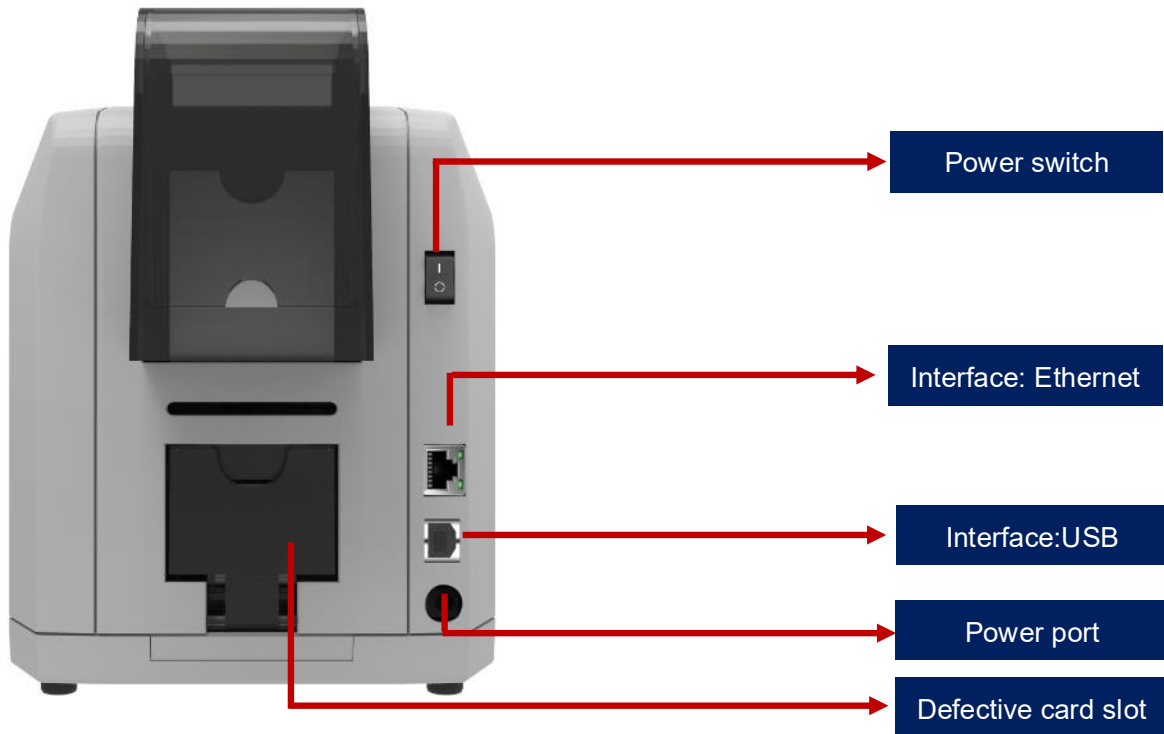

Main function description:

- (1). Defective card slot: defective cards storage place, 30pcs 0.76mm PVC cards input capacity.
- (2). Ethernet Interface: RJ45 interface, TCP/IP protocol, through this interface can achieve PC and card printer network connection.
- (3). USB Interface: USB-B type interface, connect directly to PC side.
- (4). Power port: DC24-25.5V 2.7A.
- (5). Power switch: connect or disconnect power.

i Support USB and Ethernet two communication interface. It's recommend to choose one.

3.4 Back-end

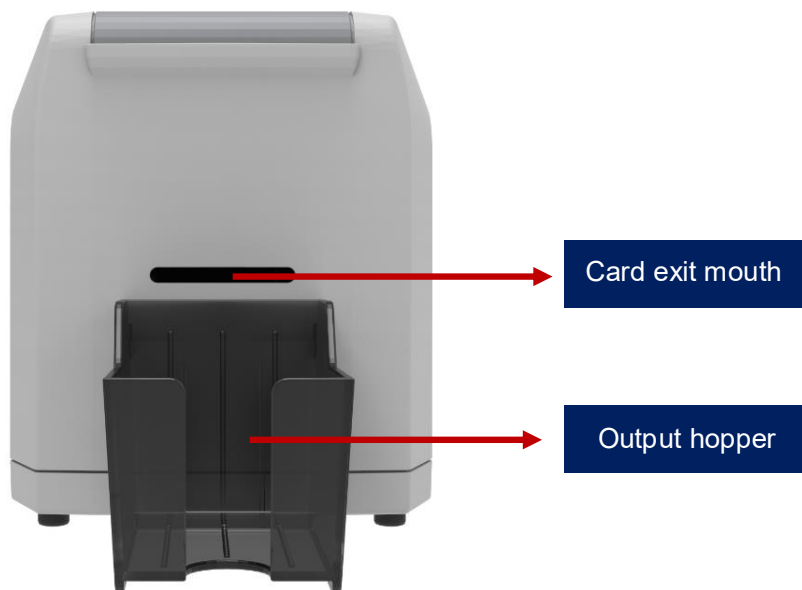

Main function description:

Card exit mouth: It can be Manual single card feeding mouth or Back-end card exit mouth. Card spit out length can be set freely.

Output hopper: Storage printed cards, 50pcs 0.76mm PVC cards input capacity.

3.5 Bottom



Main function description:

Bottom cover: Place to install Magnetic stripe card and chip card encoding module.

i Card printer bar code: Information needed when you need technical services from us.

3.6 Internal structures

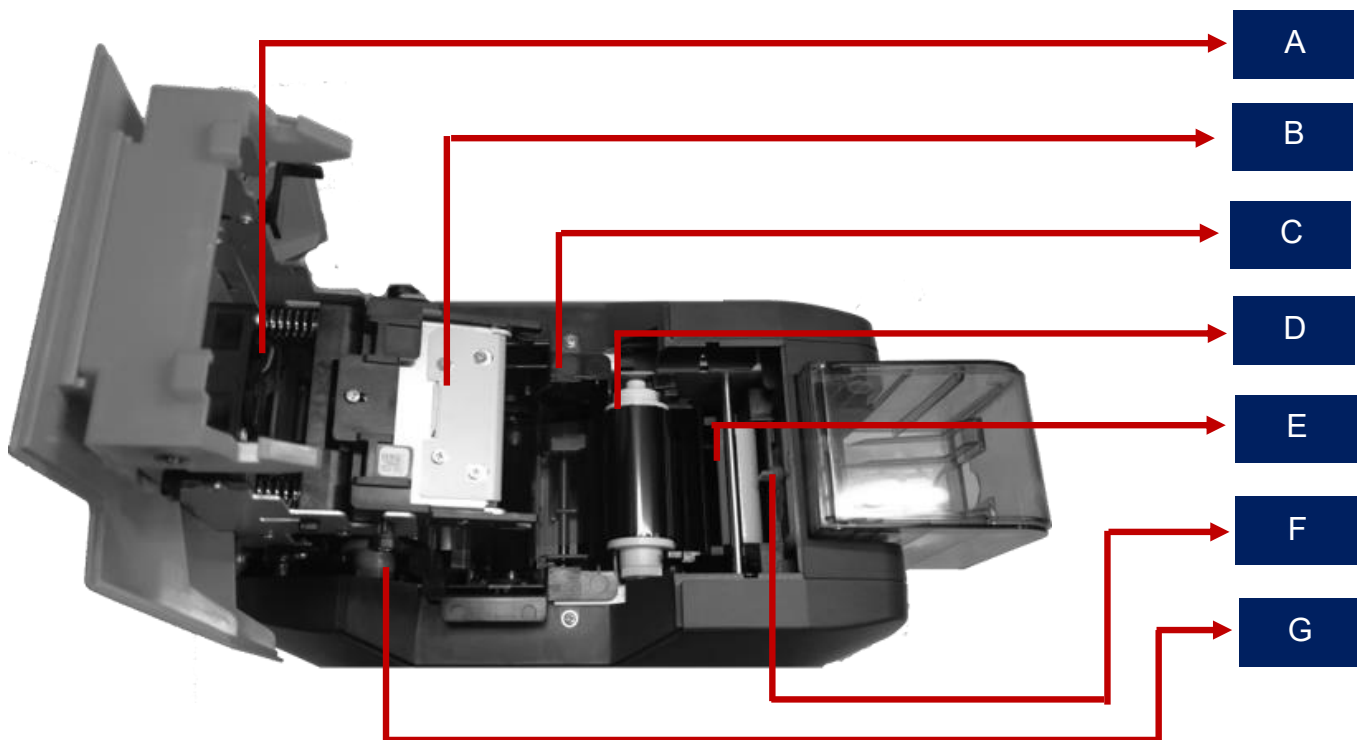

Main function description:









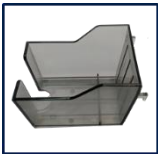

- A Air fan: absorb and release the print head’s heat when it works.
- B Print head: need regular cleaning.
- C Ribbon cartridge: accessory to install ribbon.
- D Ribbon pickup roller: recycle used ribbon.
- E Cleaning roller: sticky card surface dust, improve the printing effect.
- F Card thickness regulator: Manual adjust card’s thickness, support 0.3mm-1.0mm thickness cards.
- G Ribbon supply roller : unused ribbon ends.

4. Accessories included

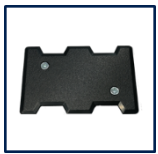
4.1 Open-case inspection



4.2 Accessories list

- | | | | | |
|---|---|---|---|---|
|  |  |  |  |  |
| Output hopper
1PC | Power adapter
1PC | Power cable
1PC | USB cable
1PC | Counting module
1PC |
|  |  |  |  |  |
| Cleaning roller
1PC | Cleaning card
5pcs | Warranty card
1PC | Cleaning stick
1PC | CD
1PC |
|  | | | | |
| Input hopper cover
1PC | | | | |

Main function description:

- (1) Output hopper: Storage printed cards, 50pcs 0.76mm PVC cards input capacity.
- (2) Power adapter: convert DC voltage.
- (3) Power cable: connect to power adapter.
- (4) USB cable: communication connection between PC and card printer.
- (5) Counting module: add weight while inputting card, increase the contact area between the card and the incoming card wheel to ensure the stable incoming card when the few cards in input hopper.
- (6) Cleaning roller: sticky card surface dust, improve the printing effect.
- (7) Cleaning card: double-sided 3M standard card, cleaning card printer internal card passing channel dust.
- (8) Warranty card: need to use it while supply technical service, please keep it properly.
- (9) Cleaning stick: cleaning the print head.
- (10) CD: storage ICARDE software, card printer driver, operation instruction etc.
- (11) Input hopper cover: prevent the card dropping when card is full or dust into the card slot.

5. Installation and usage

5.1 Install cleaning roller

Step1: Gently lift the upper cover switch, open upper cover.



Step2: Take out the ribbon cartridge.

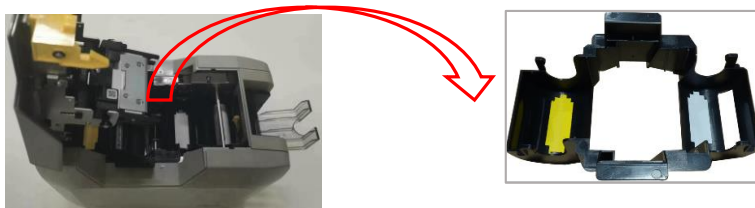

Step3: Remove 3M hyaline layer on cleaning roller surface, take the cleaning roller's both sides by hand. After pushing into the mounting position, gently press down.

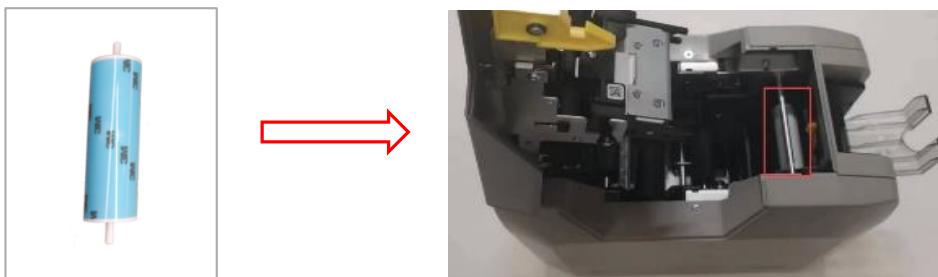

i The purpose of cleaning roller is to absorb the dust on the card and card feeding path, improve the printing effect.

5.2 Install ribbon

Step1: Open the ribbon box, take out the ribbon.

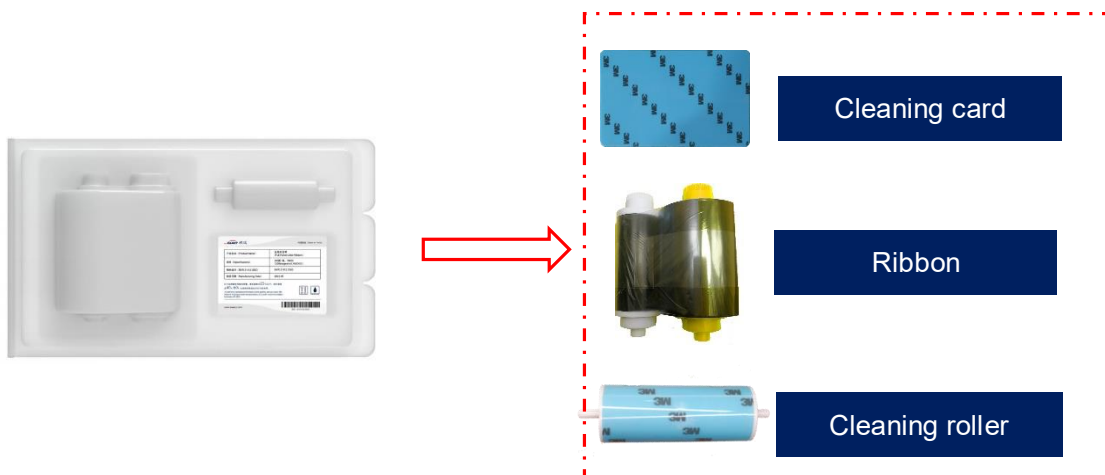

i In order to ensure the normal use of the printer, please use Seatory original ribbon.

Step2: Install the ribbon into the cartridge according to the color direction.

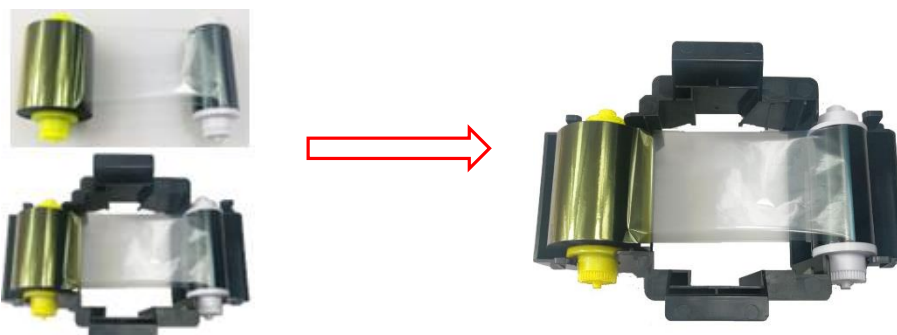

i Yellow roller supply with unused ribbon. White roller supply with used ribbon.

Step3: As shown in picture below, take ribbon cartridge's side, install the ribbon cartridge and close the upper cover.

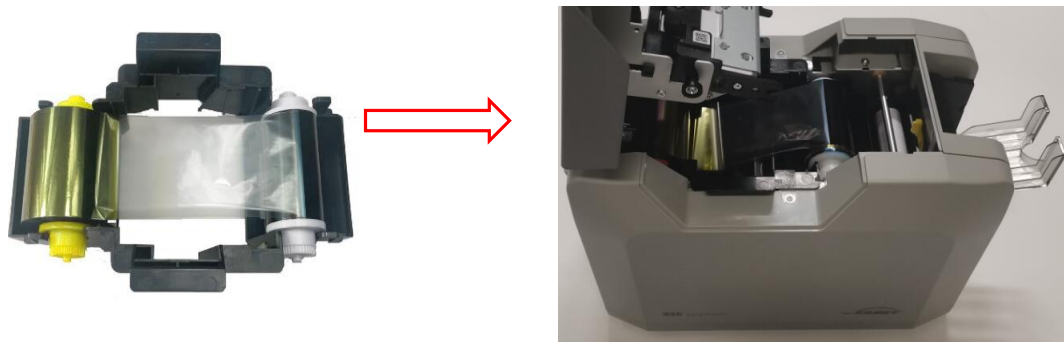

 Ribbon mounting direction: Red roller close to the Back-end card exit mouth(left), white roller close to the input hopper (right).

5.3 Adjust the feed card thickness

Open the upper cover and input hopper dust cap, move the yellow lever to adjust the feed card thickness. Support 0.3mm to 1.0mm thickness cards. Factory preset thickness is 0.8mm.

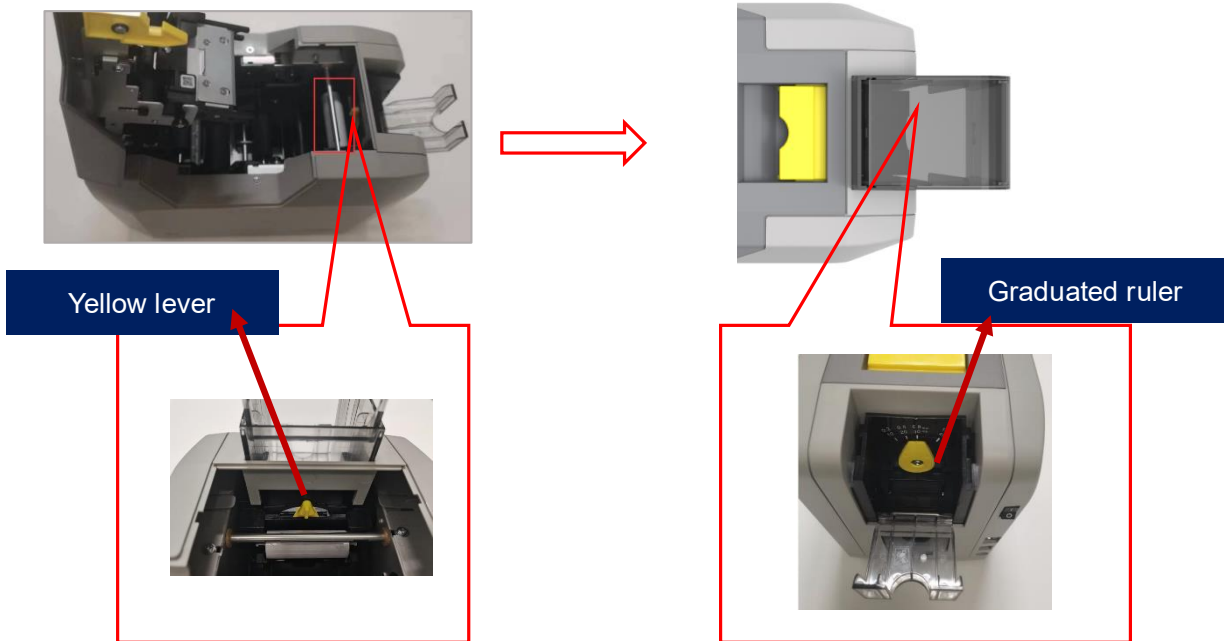

Figure 1

Figure 2

Figure 1: The feed card thickness needs to be adjusted according to the card's actual thickness.

Figure 2: Factory preset thickness is 0.8mm.

5.4 Place the card, Add the weight module

Step1: Open the input hopper dust cap, Place the card.

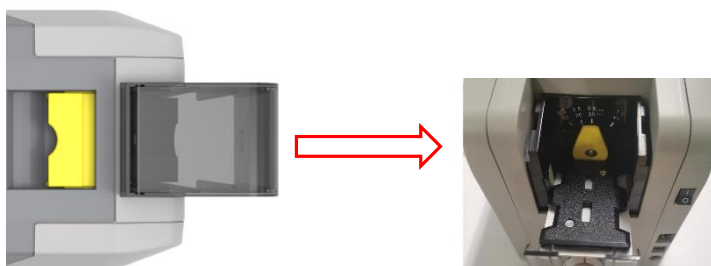

For the blank or contactless chip cards, No place direction demands

Contact chip cards require the chip face up, otherwise data can not be read or written to the chip card. (Put the card like an ATM direction)

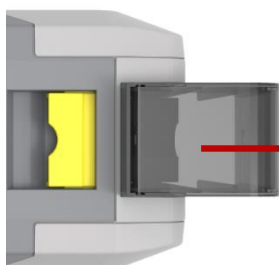

- Chip face up
- Chip toward card exit mouth

If you are using magnetic strip card, please place the card according to below picture. (Magnetic strip at right side)



- Magnetic side face down
- Magnetic strip at right side

Step2: Add the weight module

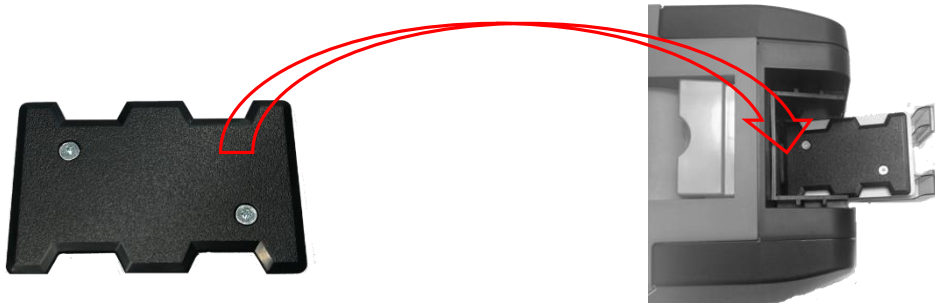

It's function is to increase the friction between the card and the roller, making the card feeding more smoothly.

5.5 Install output hopper

Attach output hopper to the card printer's card exit mouth at back side.

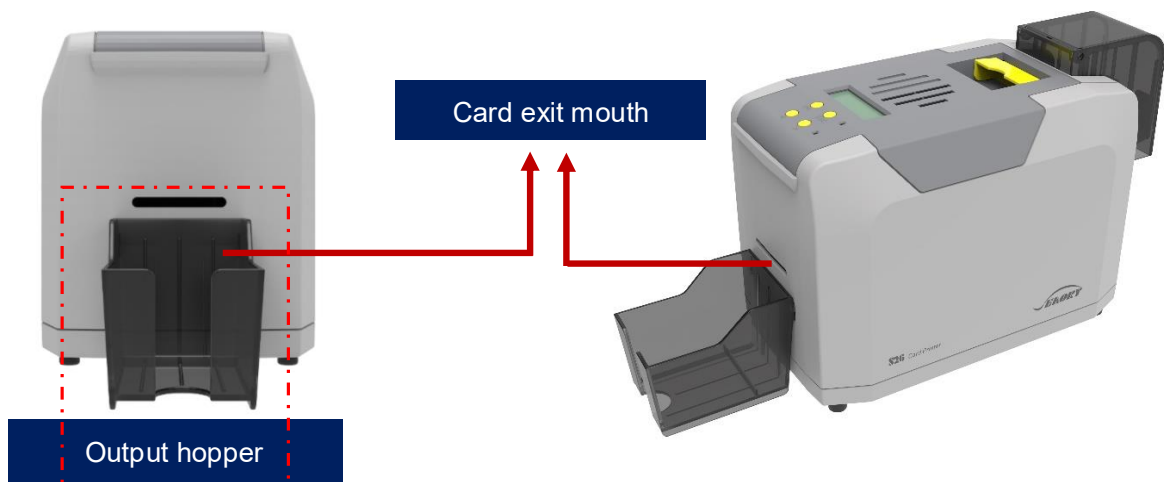

Output hopper is to storage printed cards.

5.6 Wiring installation

Step 1: Take out the power cable and power adapter from the accessories box. Connected all cables as below picture.

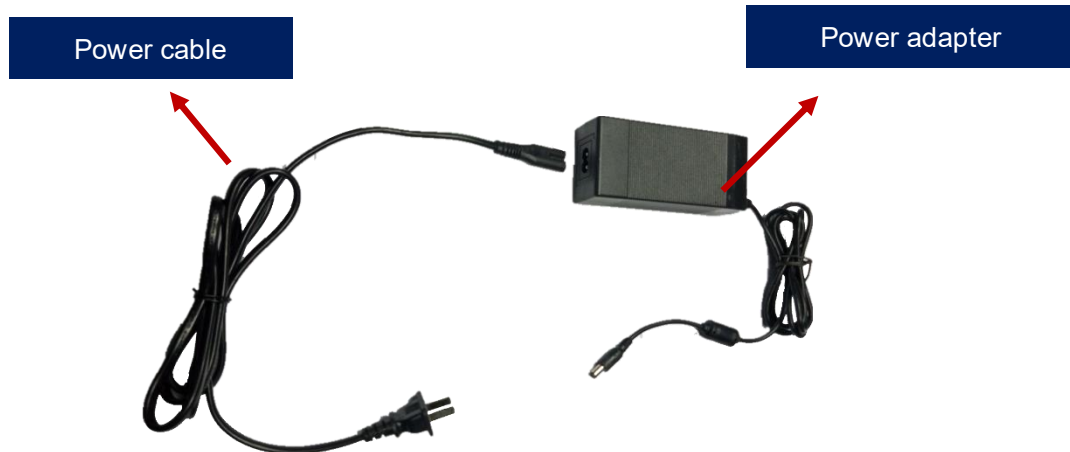

Step 2: The power adapter DC output connected to the card printer power interface, and the power line AC input connected to the mains socket.

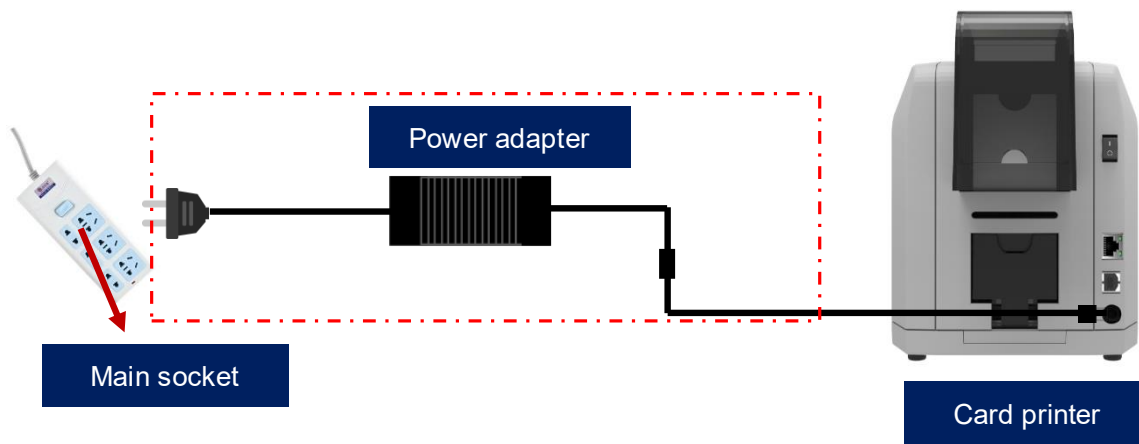

i To ensure the card printer work stably, please use Seaory original power adapter.

Step 3: Communication interface cables installation

USB communication interface installation: USB-A interface (square type) connect to PC end and USB-B interface (round type) connect to card printer's USB port.



Ethernet communication interface installation: RJ45 network interface, 568B connection mode.

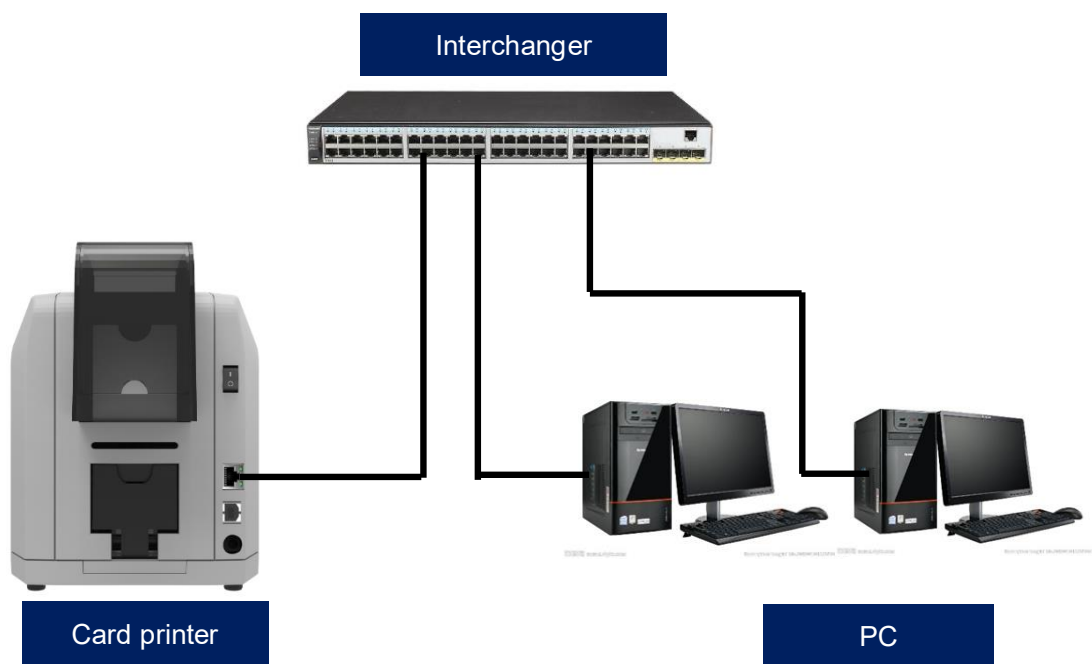

i Support USB and Ethernet communication interface. It's recommended to choose one.

6. Driver installation

6.1 Operation system

Support Windows XP/7/8/10, Windows Server 2003/2008/2012/2016, Linux

6.2 Notice before installation

(1) Card printer driver can be download from accessories box's CD or official website :www.seaoryprinter.com.

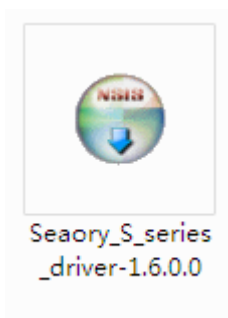

(2) Some antivirus applications will stop the driver installation, so please close all antivirus applications before installation. After finished, you can open all antivirus applications.

(3) Please do not power on card printer until the driver installation is completed.

 The driver will be continuously updated, the version number will be the actual version.

(4) Connect card printer power supply and USB communication interface in advance (please refer to 5.5 wiring installation).

6.3 Driver installation steps (USB communication interface)

Step 1: Double-click the icon “Seaory S series driver exe”.

i Please install driver by administrator and close all antivirus applications before installation.

Step 2: Then click “Install” button as show in below picture.

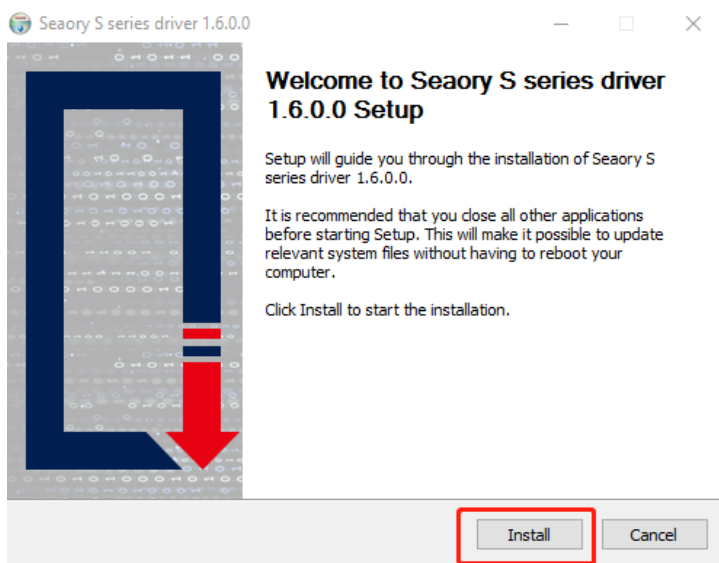

Step 3: Wait for one minute.

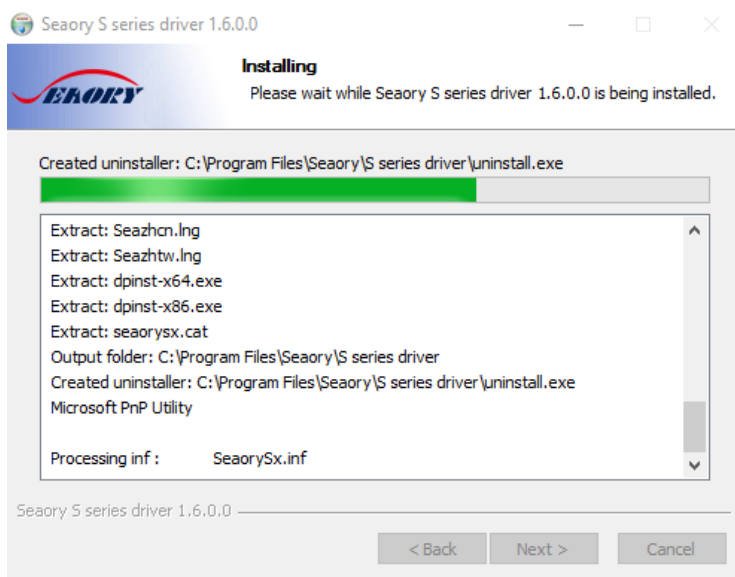

Step 4: Please select always trust software from “Shenzhen Seaory Technology Co., Ltd.” in the pop-up windows, then click the “Install” button.

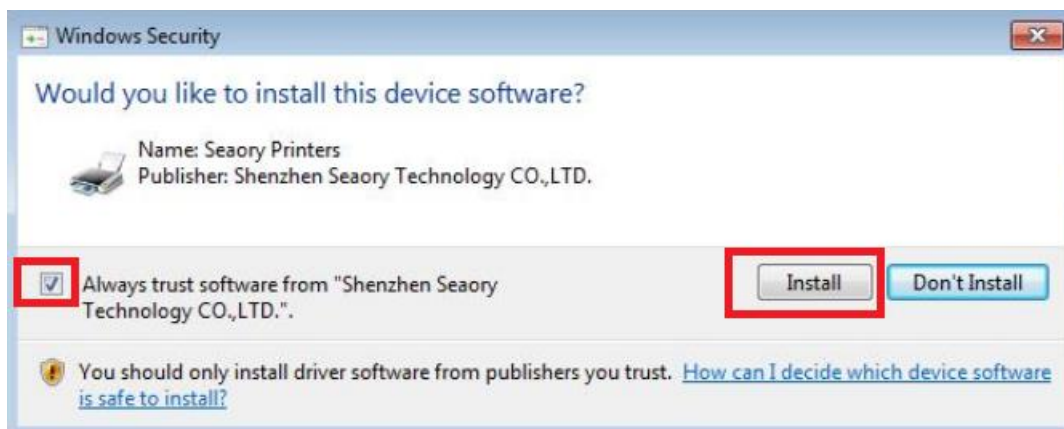

Step 5: Please click the “Finish” button as show in the below picture, then the driver has been installed.

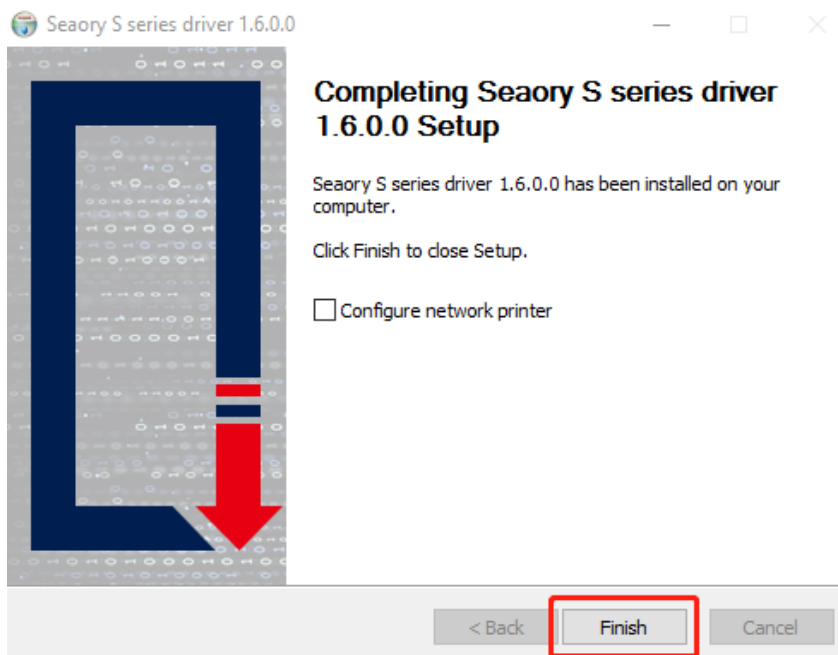

Step 6: Turn on the card printer power switch, then card printer driver will install automatically. After it, click “Control panel – Hardware and sound – Devices and printers” you can find Seaory S26 was installed completely.

Projectors

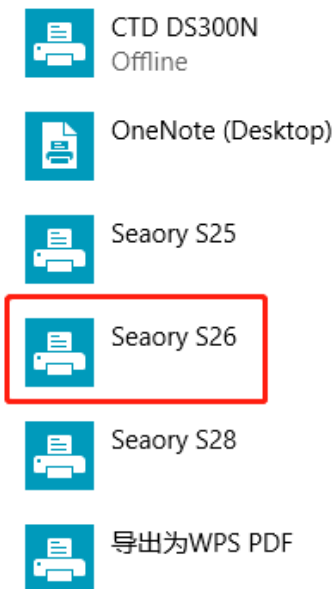

6.4 Network setting

If you need to use Ethernet communication interface, please make sure the USB interface was connected with PC before operating as below:

Step 1: Put your mouse on the selected “Seaory S26” printer, and click the right button, from the Printer menu, select “Printing preferences”.

⚙ Seaory S26

This device has a few different functions.
Pick one to manage settings for that function.

App installed Manage your device

Open queue

Print a test object

Scanner:

Scanner properties

Printer properties

Open printer app

Step 2: Select “Tool” – “Network Setting”

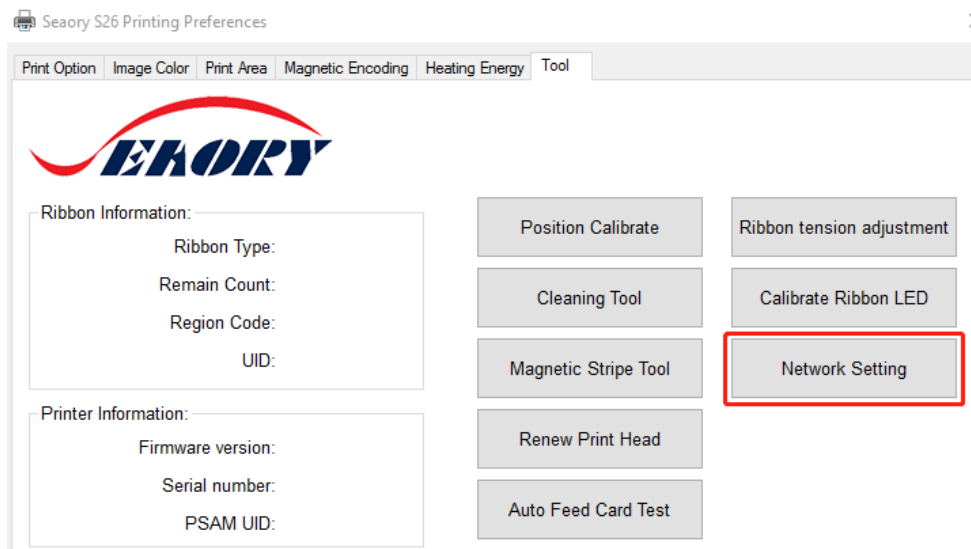

Step 3: After click “Network setting” ,choose “Gets current setting” ,you will find the card printer Model number, firmware version, MAC address etc.

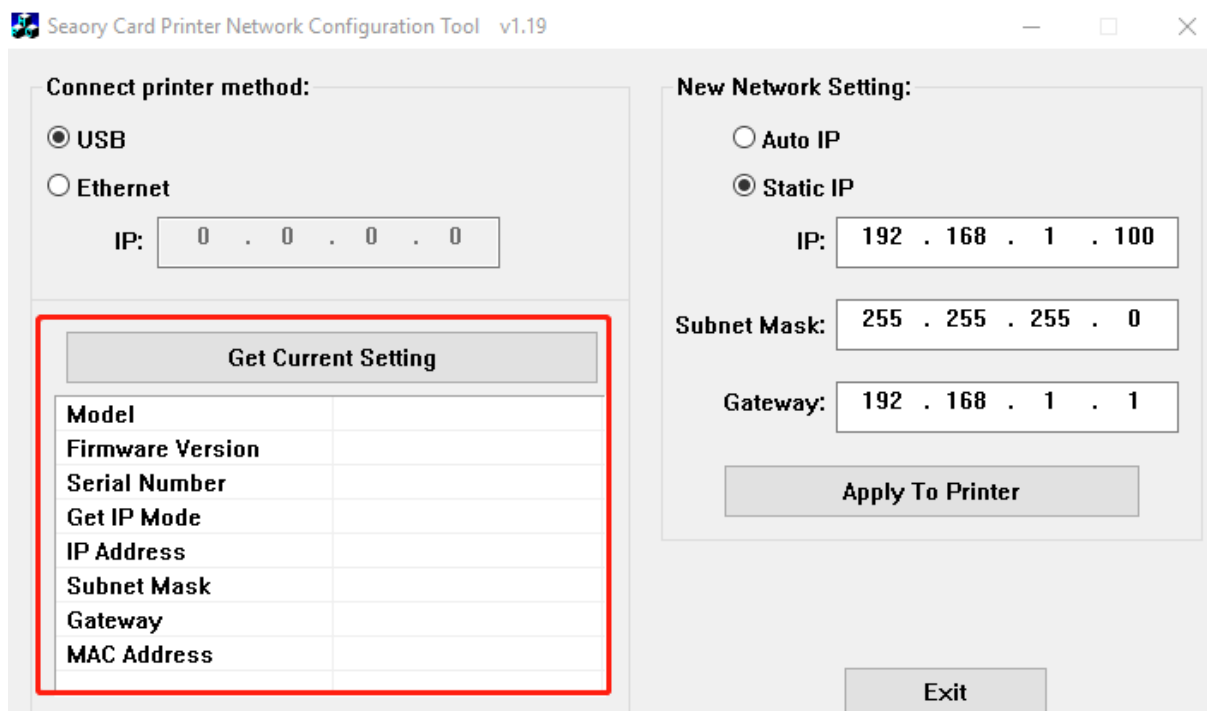

Step 4: Click “Static IP”, type in internet IP address, subnet mask, gateway information. Then click “Apply to card printer”, you will see success dialog box. That means the network setup successfully.

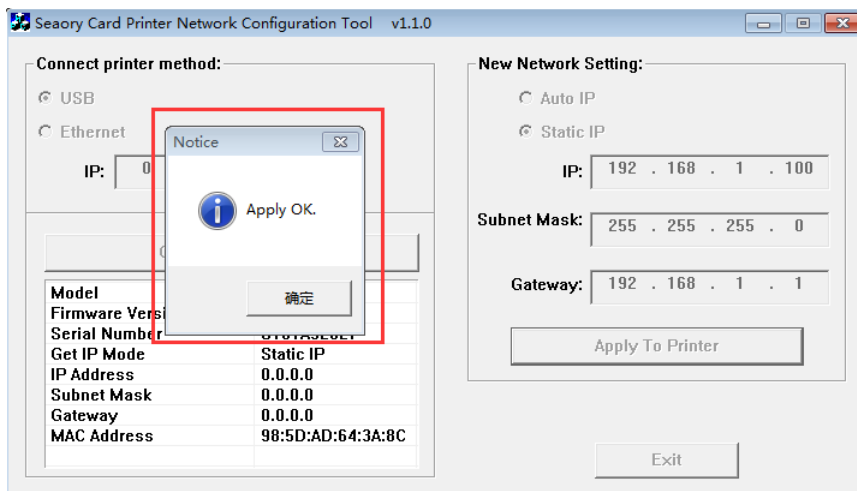

i After setting successfully, you can use the Ping network command to test the result.

6.5 Driver installation (Ethernet communication interface)

According to “6.4 network setting operating guide”, setting up the printer IP information, access to the network line and using the Ping command on the computer side to confirm the printer is communicating with the computer.

After finished “6.3 driver installation (USB communication interface)” operating guide, please operate according to following steps:

Select “Configure network printer” first, and then click “Finish”.

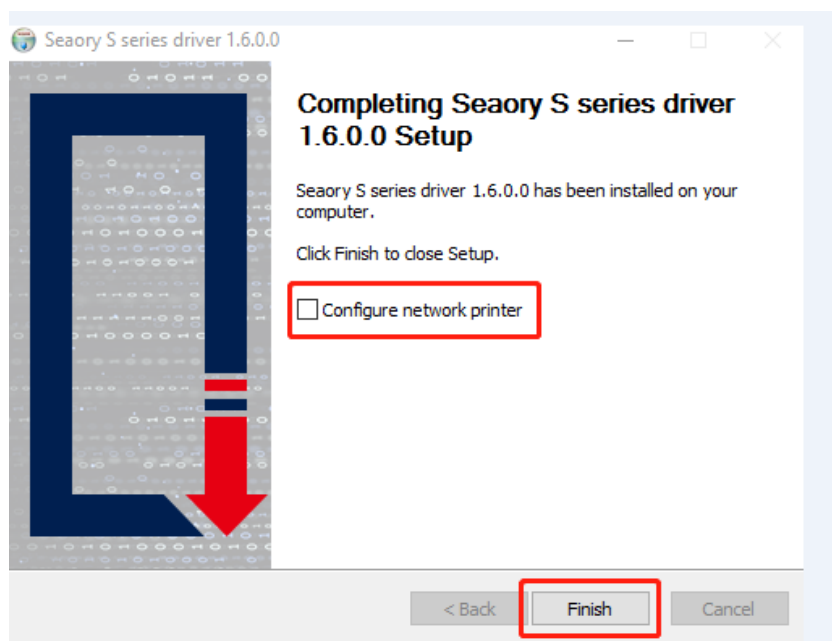

(2) Enter card printer's IP address and click "Add printer" to complete the installation.

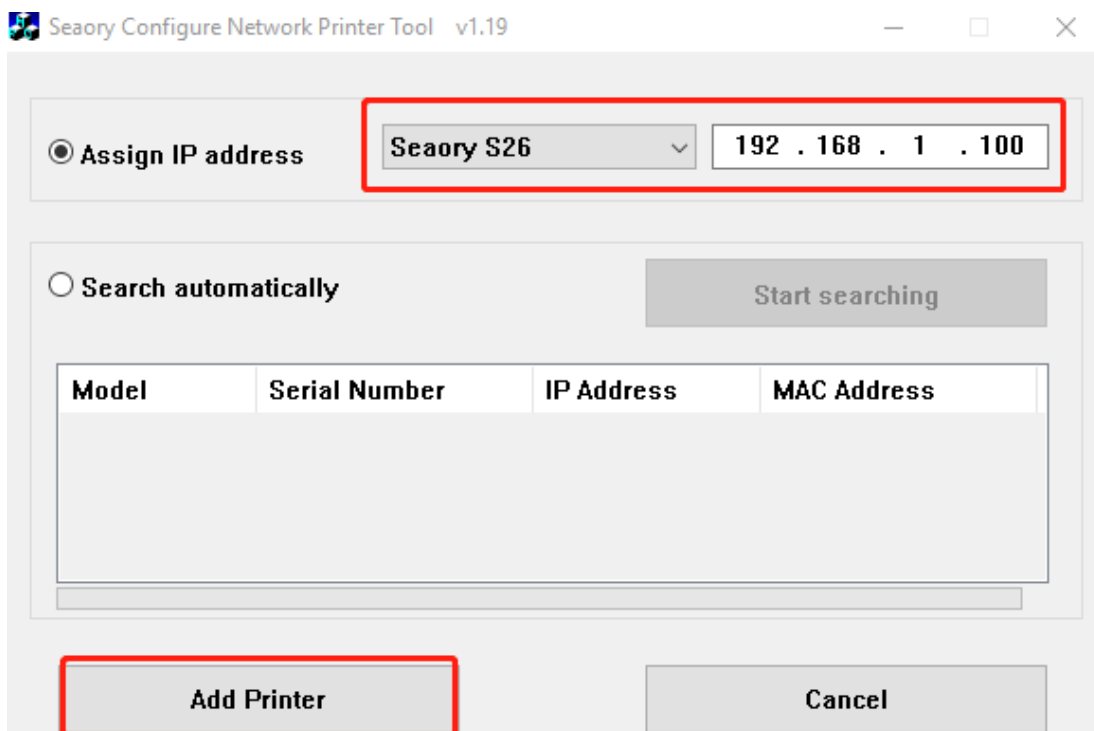

i If the card printer has set IP parameters already, you can also choose the "Automatic search" to add.

7. Driver setting

7.1 Printing preferences

⚙️ Seatory S26

This device has a few different functions. Pick one to manage settings for that function.

App installed Manage your device

Open queue

Print a test object

Scanner:

Scanner properties

Printer properties

Open printer app

Put your mouse on the selected "Seatory S26 printer", and click the right button, from the printer menu, select "Printing preferences".

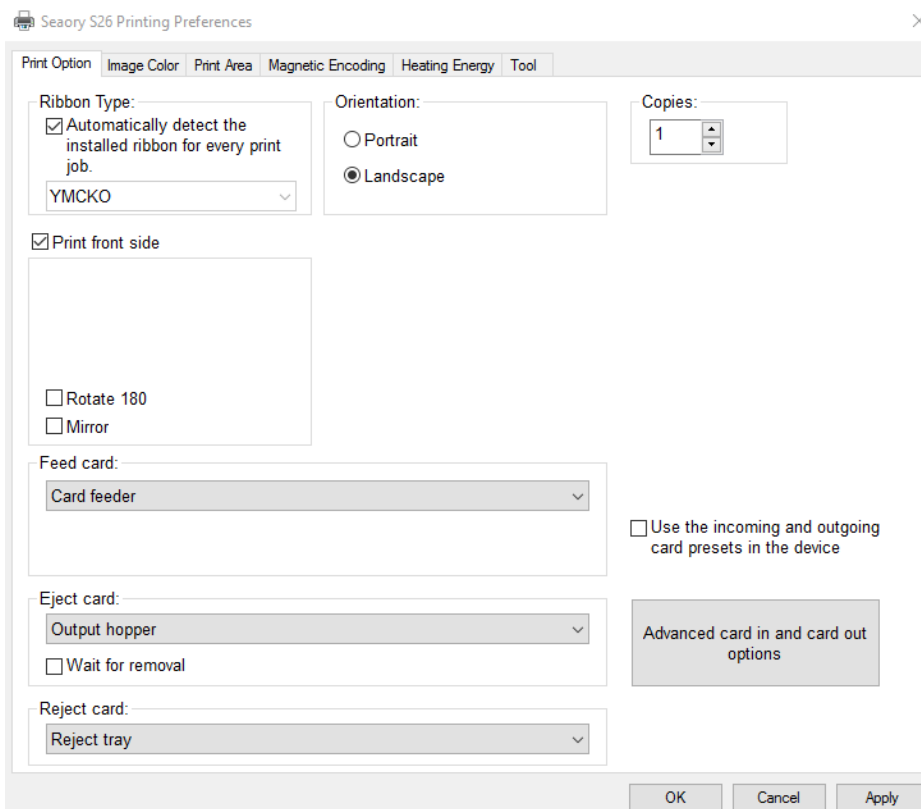

Printing preferences page

7.2 Ribbon type setting

(1) Automatically detect the installed ribbon for every print job is default chosen.

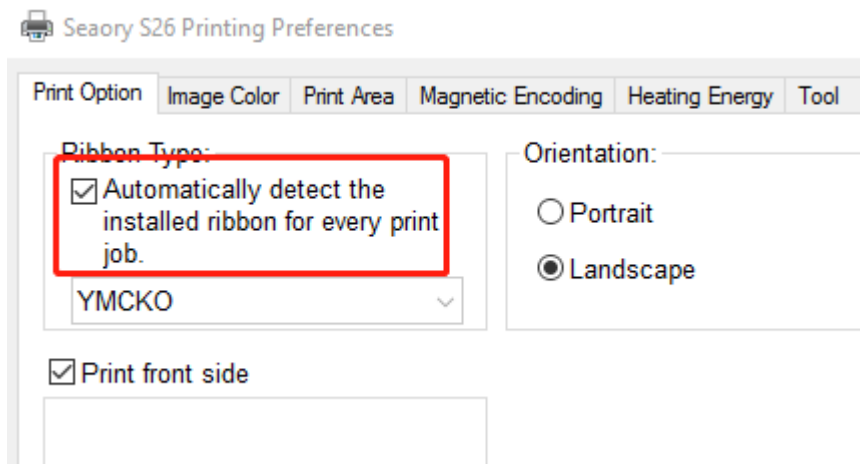

i Automatic detect the installed ribbon is default option and suggest to keep it.

(2) When “Automatically detect the installed ribbon for every print job” was cancelled, the ribbon type needs to be set manually between below choices.

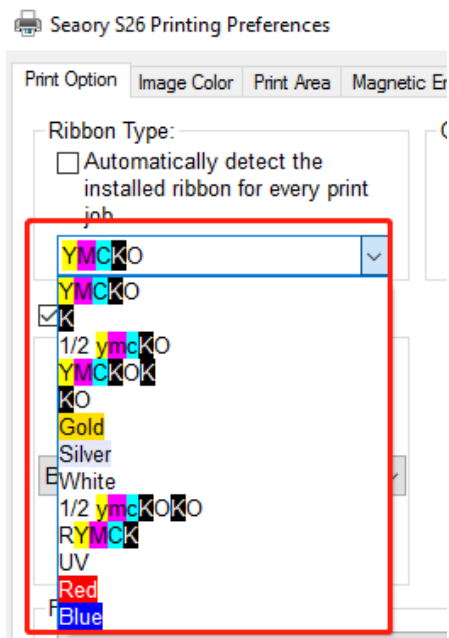

7.3 Printing orientation setting

Portrait or landscape. Default selected landscape orientation.

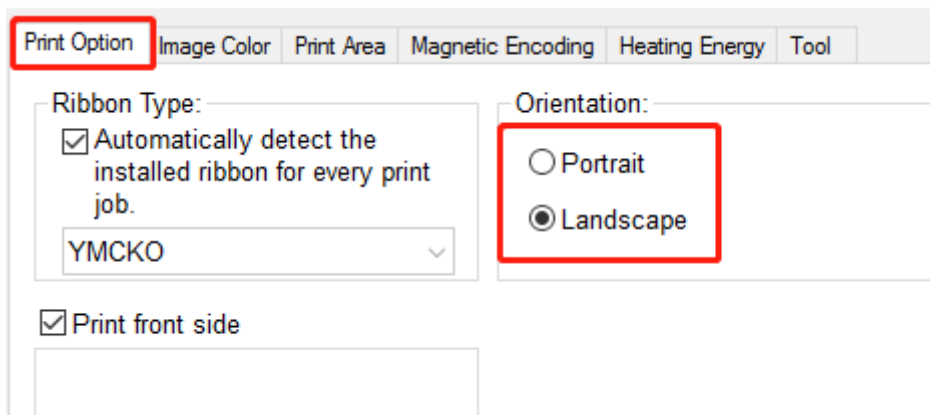

7.4 Printing page rotate setting

Default not selected, if selected "rotate 180" the printing page will rotary 180 degree.

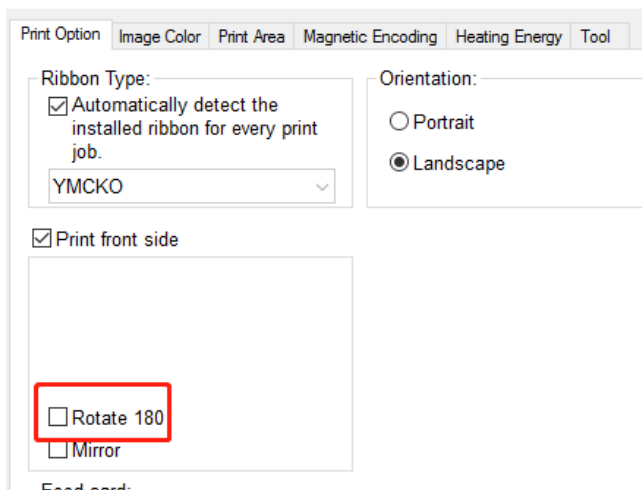

7.5 Feeding card mode setting

(1) Card feeder: Card feeding from input hopper automatically. It's default chosen.

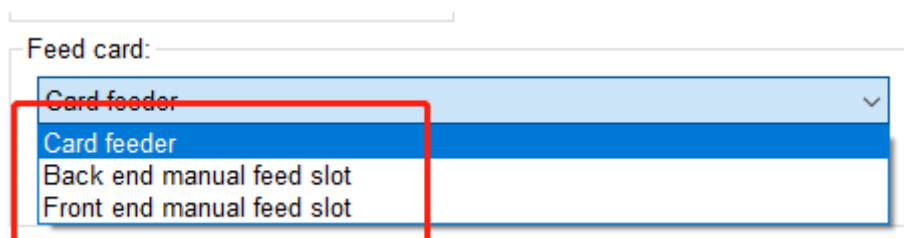

(2) Manual feeding card piece by piece from Back-end card exit mouth is optional.



(2) Manual feeding card piece by piece from front-end manual feeding mouth is also ok.

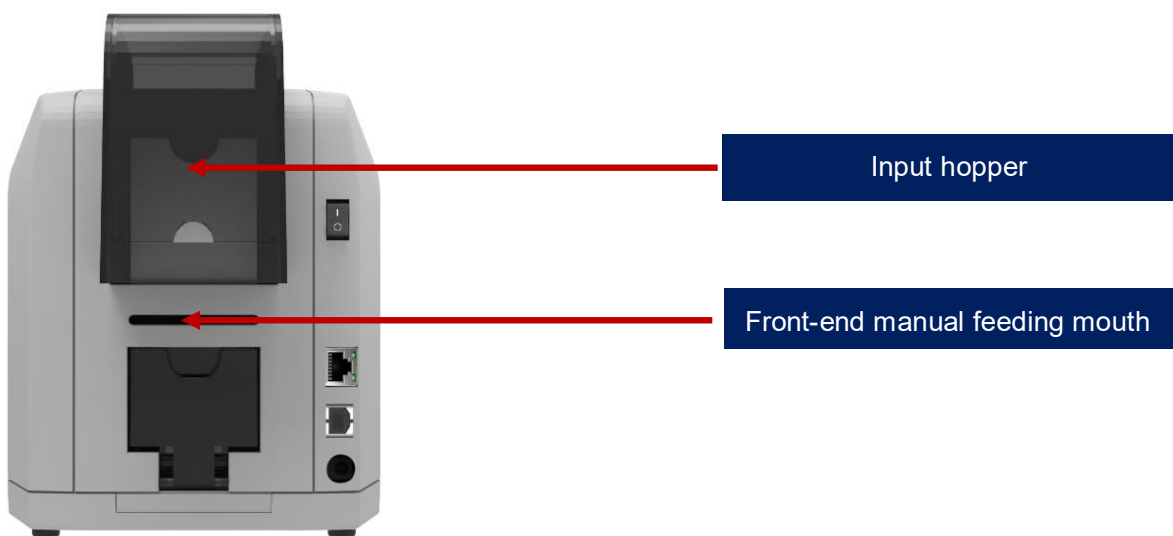

7.6 Eject card setting

- (1) Defaulted card moving out from “output hopper” after finished printing.
- (2) Wait for removal, default not selected, if selected, card will wait for removal in the ejection card slot after finished printing.

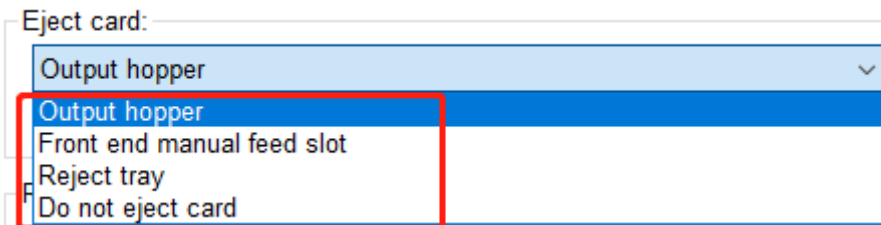

7.7 Reject card setting

You can find below page in “Printing Preferences” - “Print Option” menu..

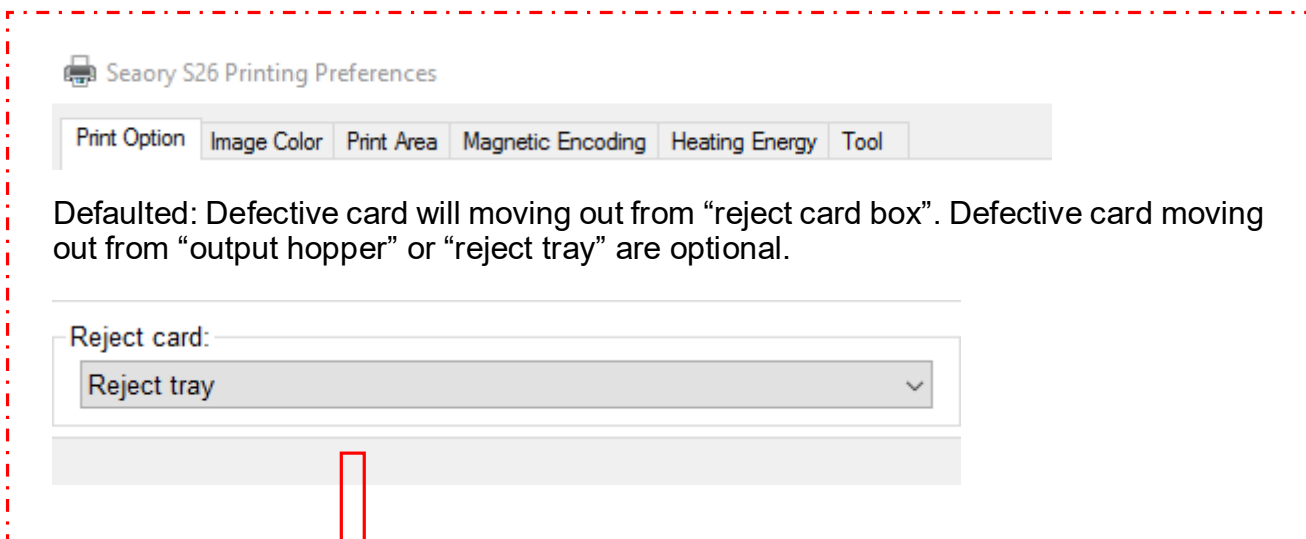

Defaulted: Defective card will moving out from “reject card box”. Defective card moving out from “output hopper” or “reject tray” are optional.

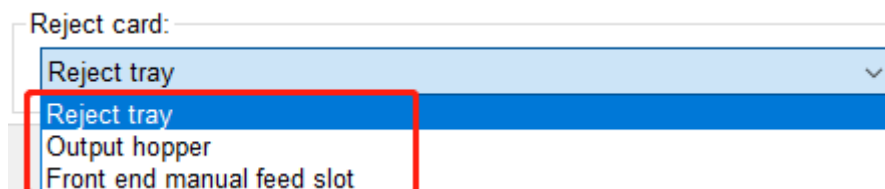
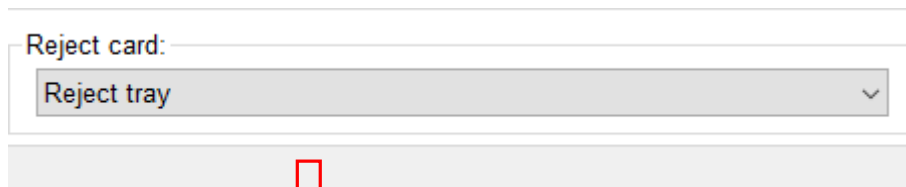

i Generally reject card box will be used when reading and writing chip cards.

7.8 Advanced card in and card out options setting

Default setting as below: It can adjust according to the actual application requirements.

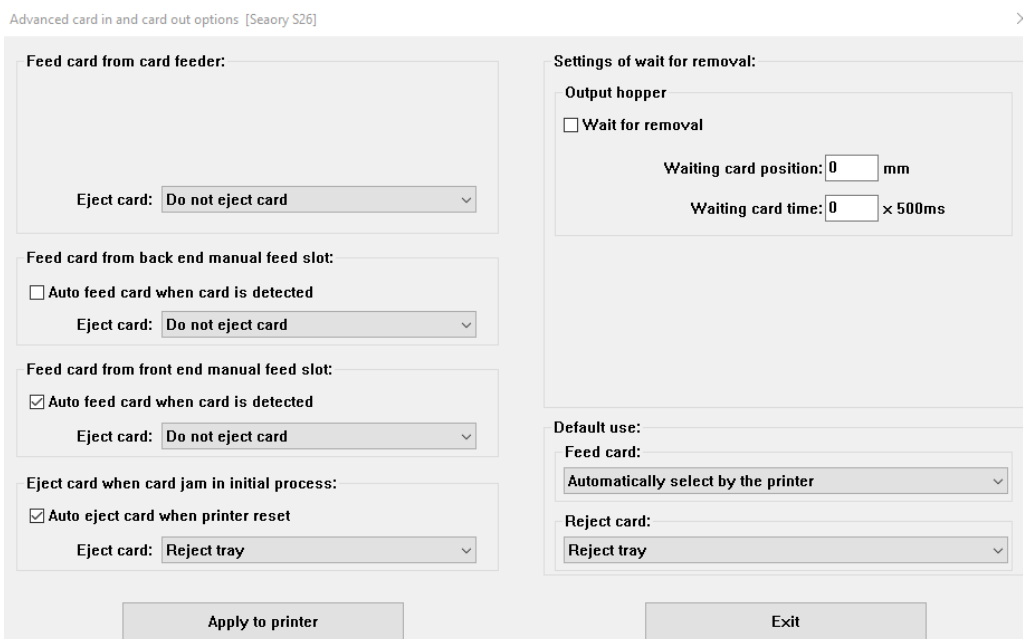
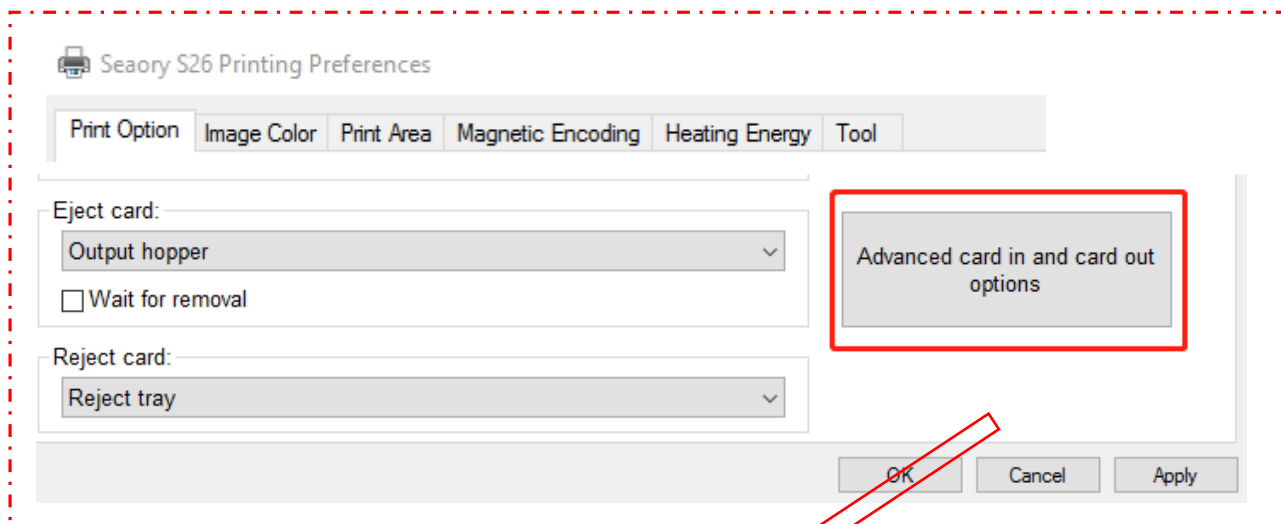

7.9 Image color setting

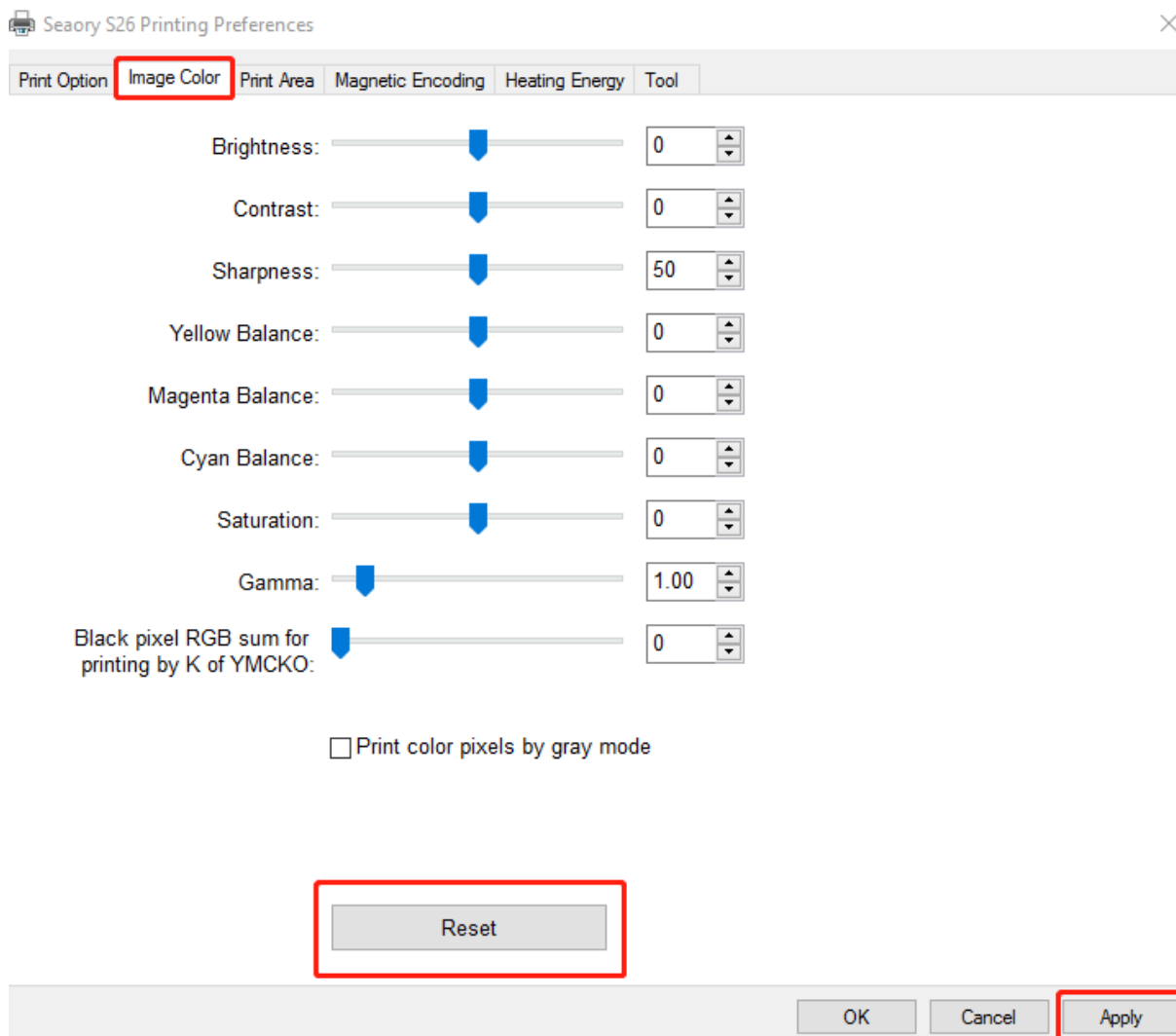

The driver default is optimal, normally it does not need to change, if has to, you can custom.

Reset: means restore factory default image color setting.

Apply: means after setting new parameter value, click “apply” to take effect.

7.10 Print area setting

(1) Default print area is full page printing.

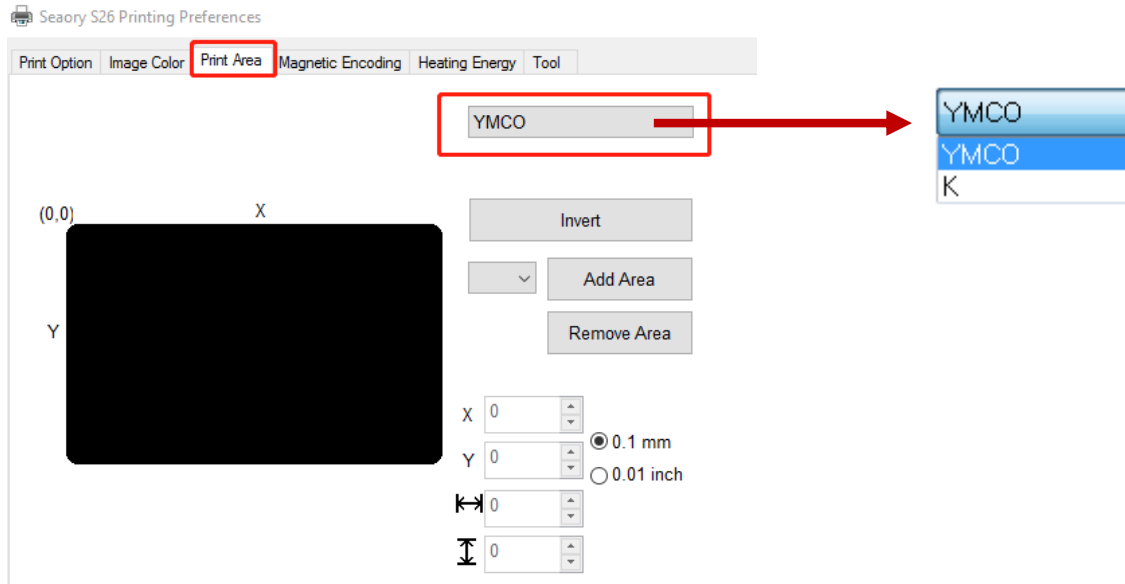

- Default YMCO and K are edge to edge printing.
- Default edge to edge printing.

i The black area in above picture is the printing area.

(2) Customize printing area

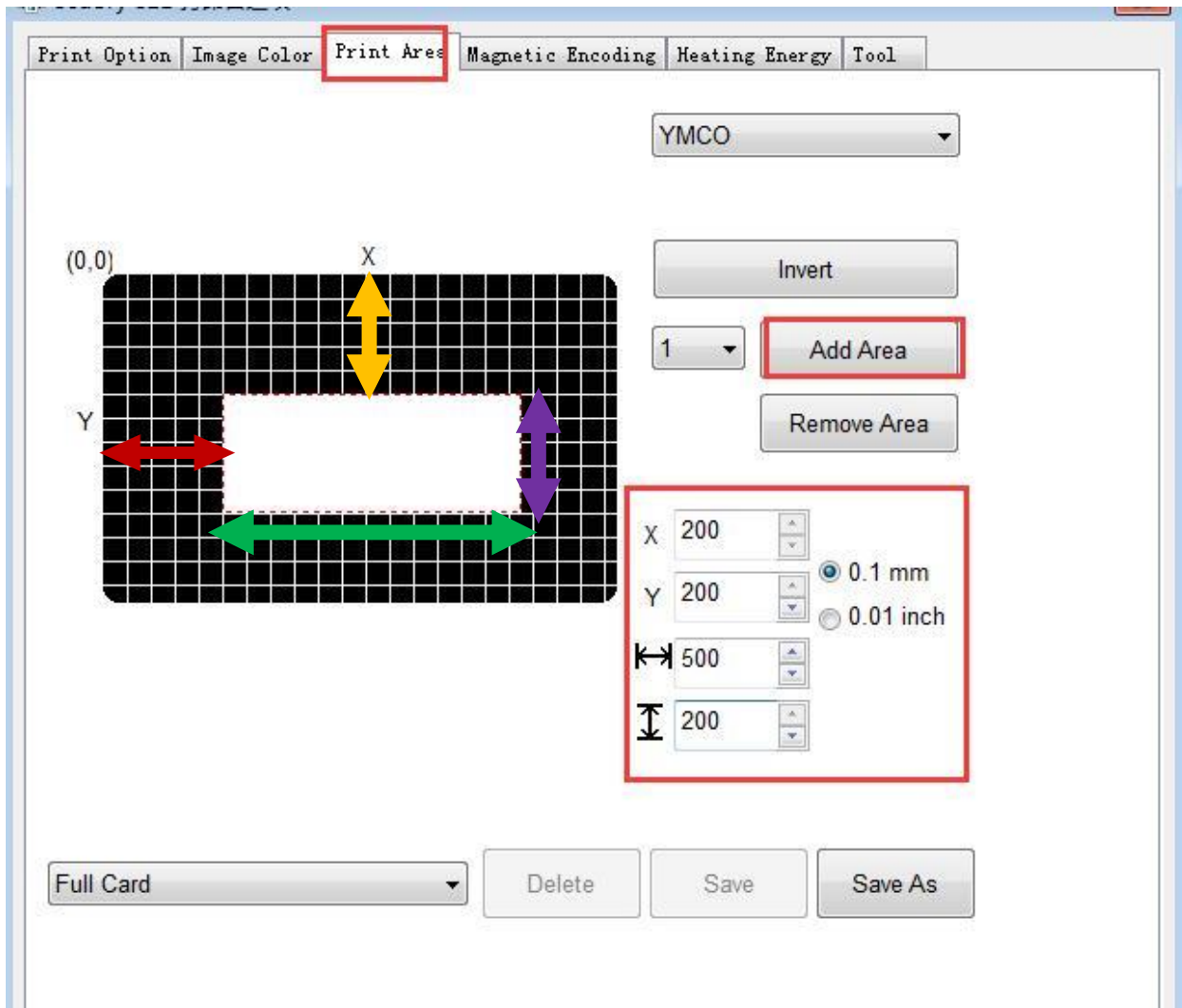

Click "add area", input or adjust X,Y value and length and width value.

- Red double arrow: represents the distance from the X-axis to the white area.
- Yellow double arrow: represents the distance from the Y-axis to the white area.
- Green double arrow: represents the white area (no printing area) length.
- Purple double arrow: represents the white area (no printing area) width.

i The black area in above picture is the printing area, white area is no printing area.

7.11 Magnetic encoding setting

Function: for any software to edit the text between the filter characters, when printing, the printer encoding the same text.

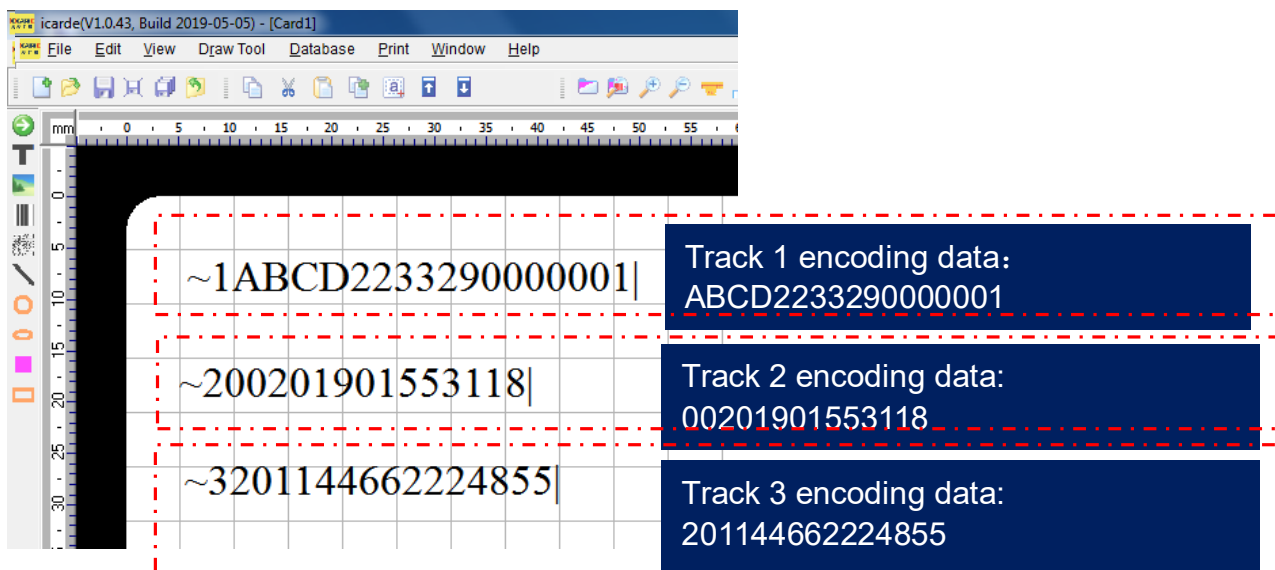
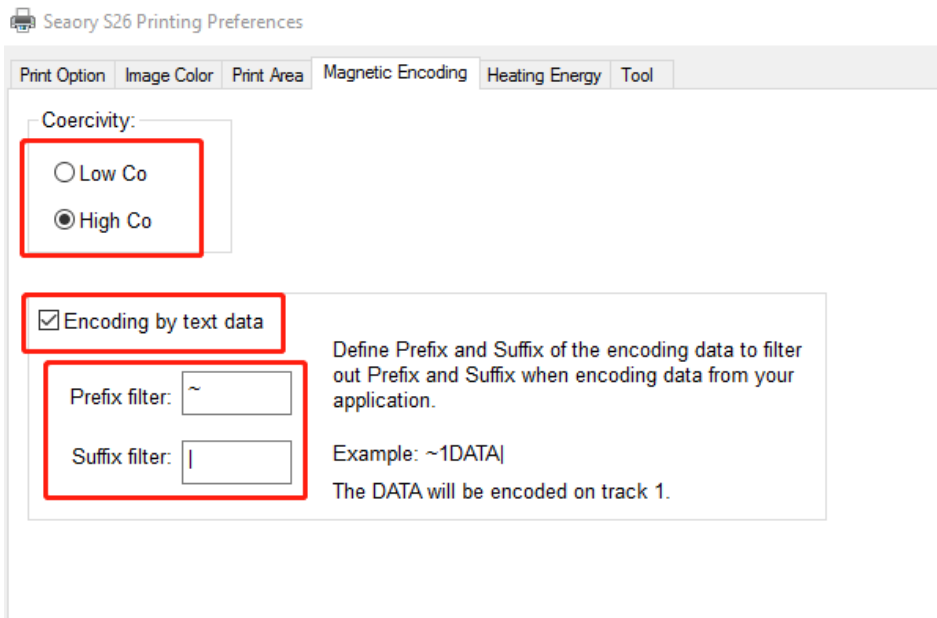

"~1" means track 1 , "~2" means track 2, "~3" means track 3. "|" means stop code.

7.12 Heating energy setting

When the printing color is relatively light, it's necessary to increase the heating energy value. When the printing color is dark or ribbon is easy to break, the heating energy value need to decrease.

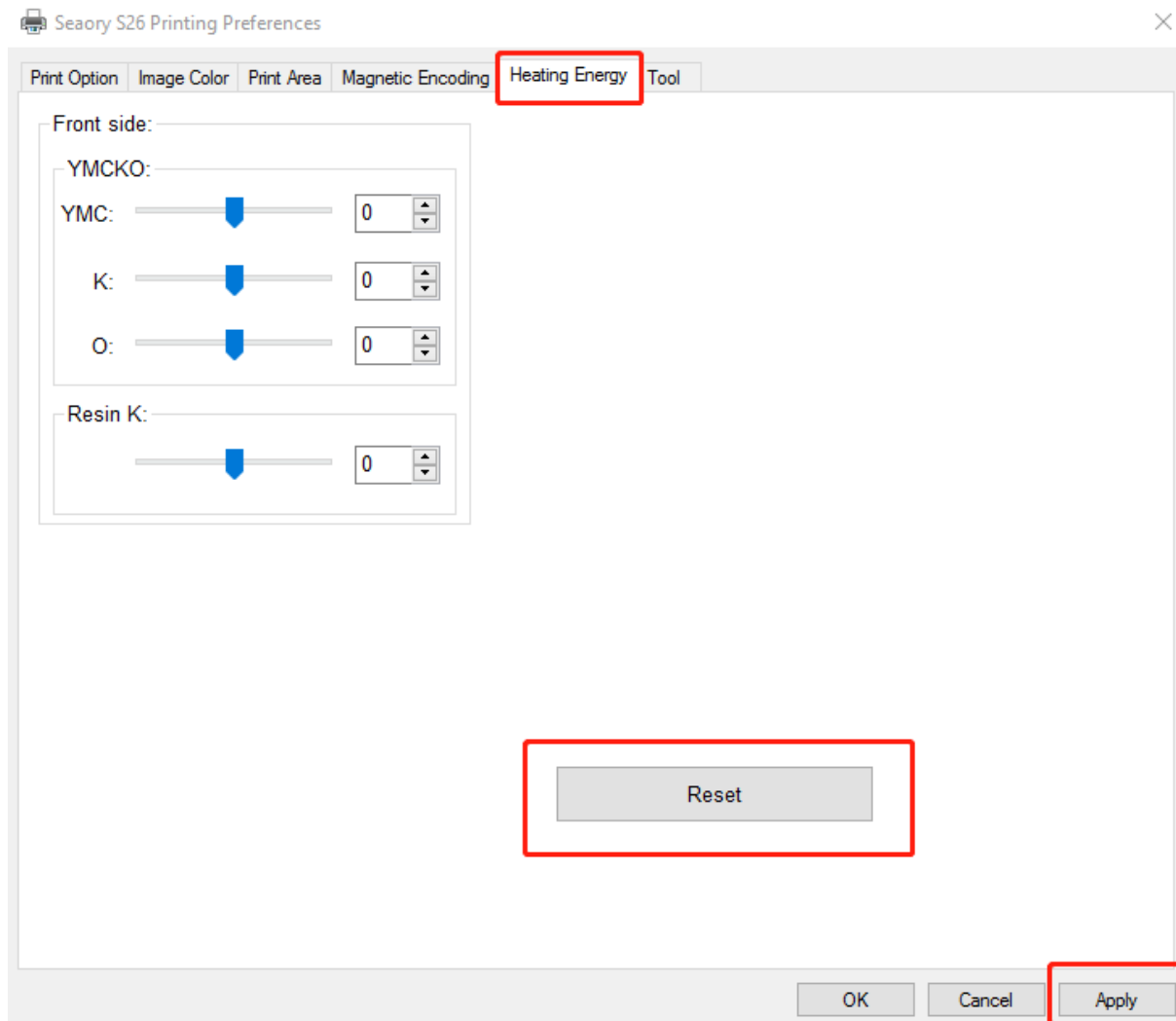

- YMCKO is for YMCKO ribbon
- Resin K is for monochrome ribbon
- Reset is to restore factory setting

7.13 Tool setting

Card printer's related information can be find as below picture.

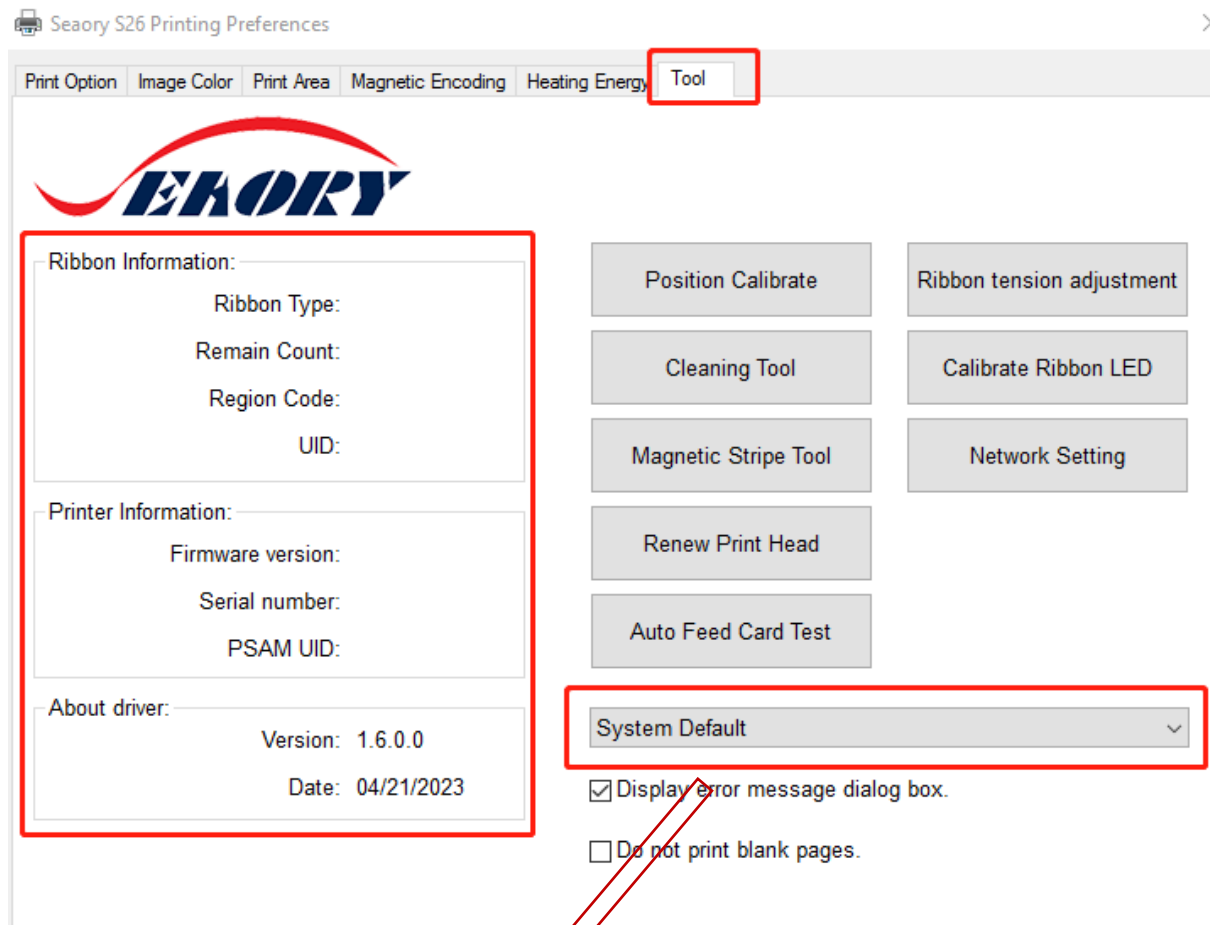

Driver will choose the same language as your computer operating system during installation. More language will be support in the future.

7.14 Position calibrate

To correct the printing position when the white edge appears on cards, and no correction is required by default.

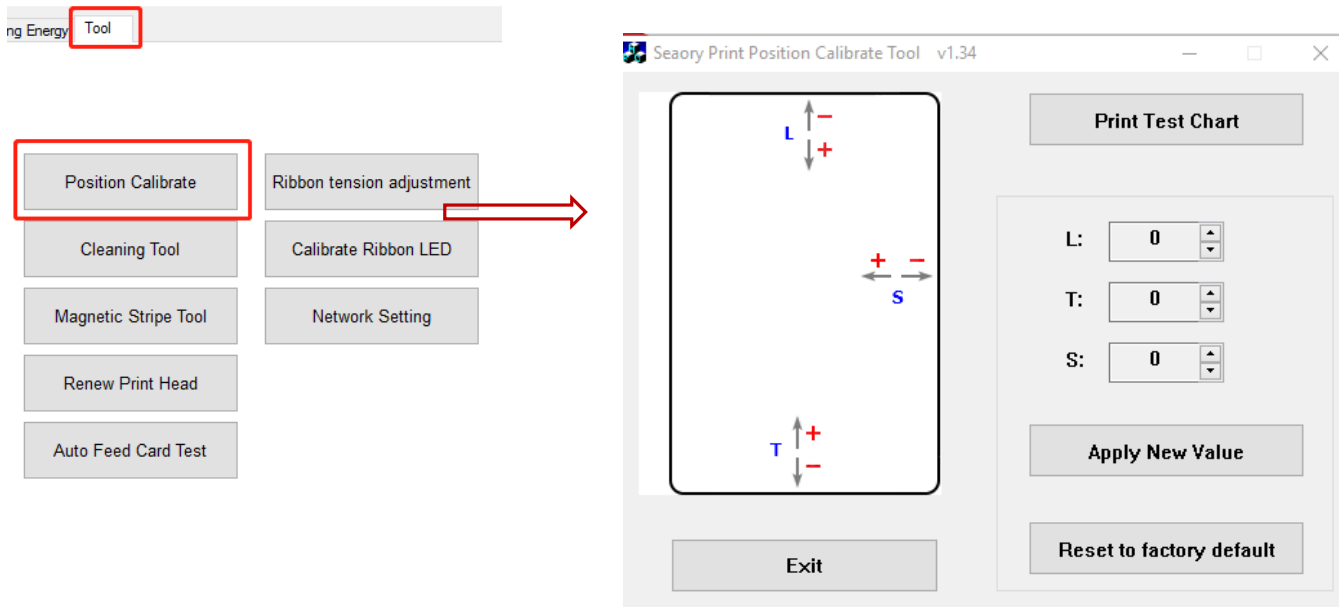

- L is print start position, decrease L value when the start side has white edge.
- T is print finish position, decrease T value when the finish side has white edge.
- Increase the L and T value when the ribbon is easy to break.
- S is print side position, decrease S value when the side has white edge.



Print test picture

i It's suggested to add or subtract 1 unit parameter value gradually according to the print effect.

7.15 Cleaning tool

Deposition of dust or contaminants inside the card printer may cause damage to important parts and affect the printing effect. Therefore, it's recommended to clean the printer when changing the ribbon or at least clean one time a month.

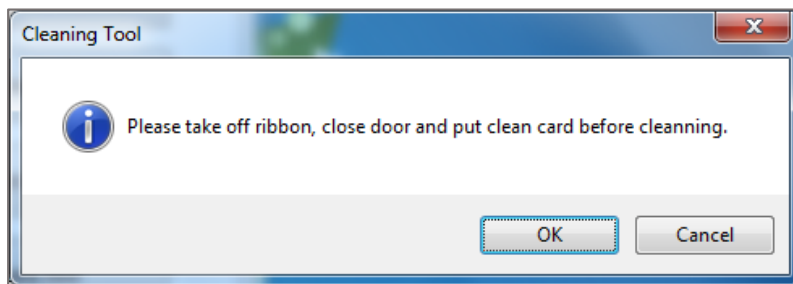
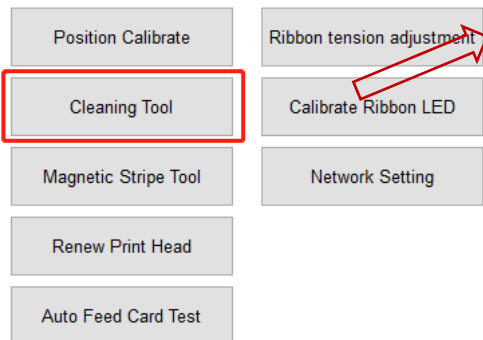
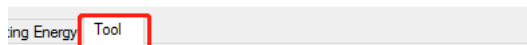

Cleaning card

- Cleaning steps according to the driver leads are as follows:
- Step 1: Take out the cleaning card from the accessory box and remove the 3M hyaline layer on cleaning card's both sides.
 - Step 2: Open card printer upper cover, take out the ribbon cartridge and then close the upper cover.
 - Step 3: Put the cleaning card into the input hopper
 - Step 4: Click "OK". The card printer will start to clean itself.
 - Step 5: After finished cleaning, please install the ribbon cartridge into card printer.

7.16 Magnetic stripe tool

The main function is to read and write magnetic strip card.

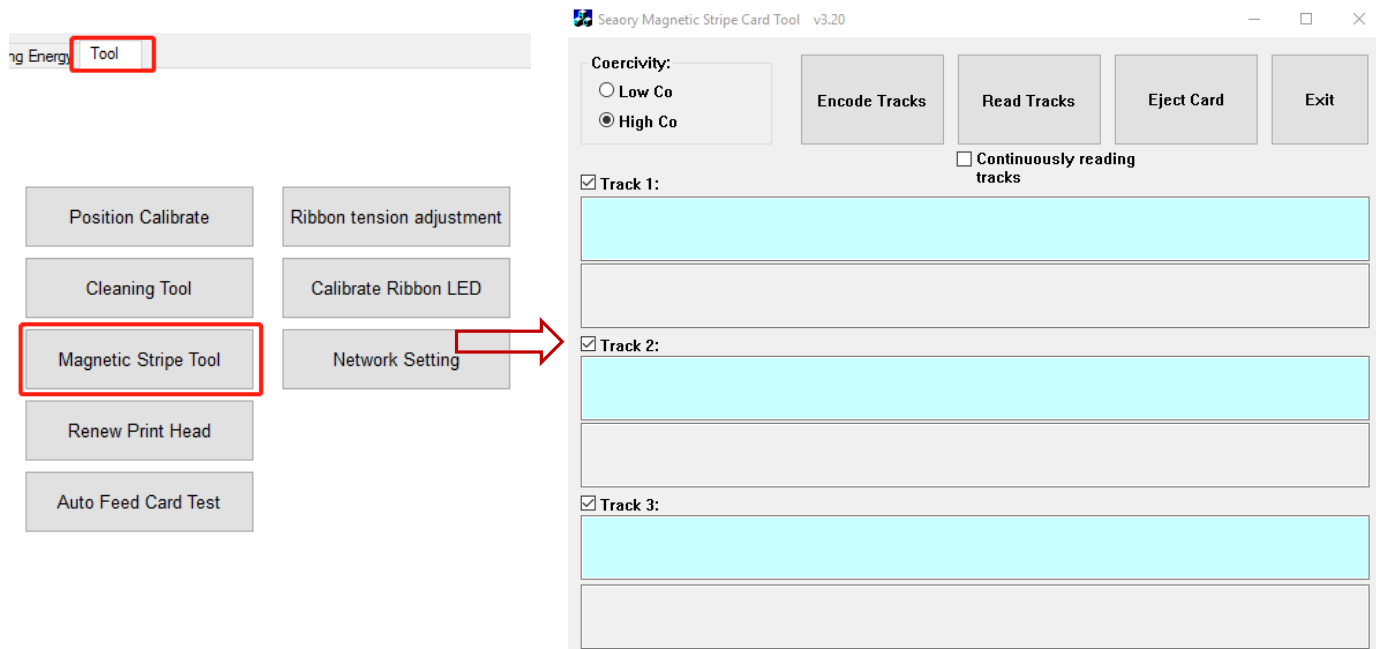

- Encode tracks: magnetic stripe card data write test
- Read tracks: magnetic stripe card data reading test
- Eject card: card move out to output hopper
- Exit: close current interface

7.17 Ribbon tension adjustment

If card's side colored lines appear: Decrease (-) white end value Or increase (+) yellow end value.

If card's inside colored lines appear: Increase (+) white end value or decrease (-) yellow end value.

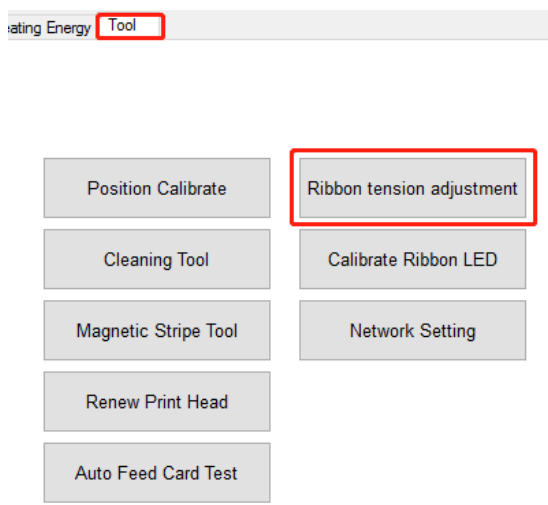

Apply to printer: after setting new parameter value, click “apply” to take effect.

7.18 Other tools

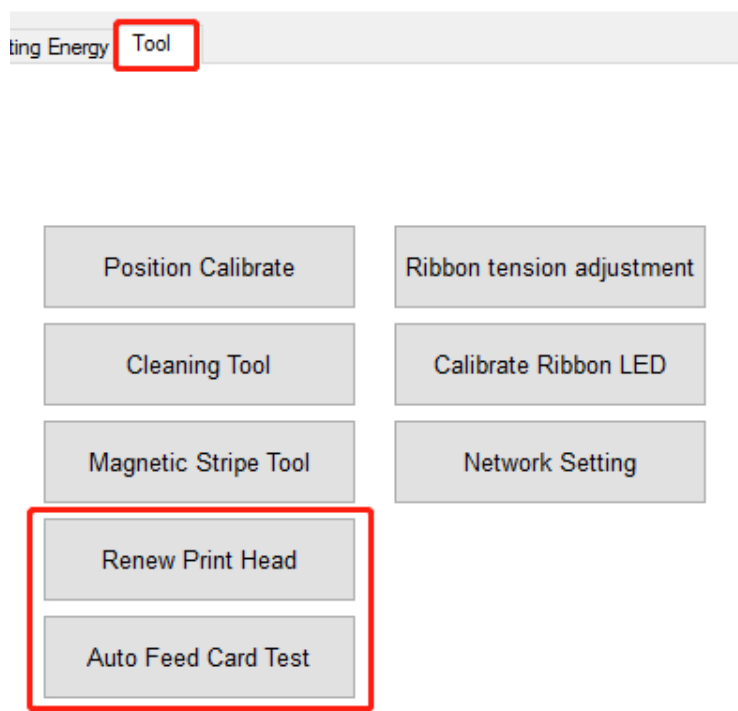

(1) Renew print head: please renew the new print head barcode after replaced print head. Otherwise it may lead to print problem.

(2) Network setting: card printer IP information reference tool. More details please check 5.4 section.

(3) Automatic card feeding testing tool: verify the card can be feeding automatically.

8. Print test

8.1 Driver test page

Step 1: open “Printing preferences”, click “Tool”, find and click “Position calibrate”.

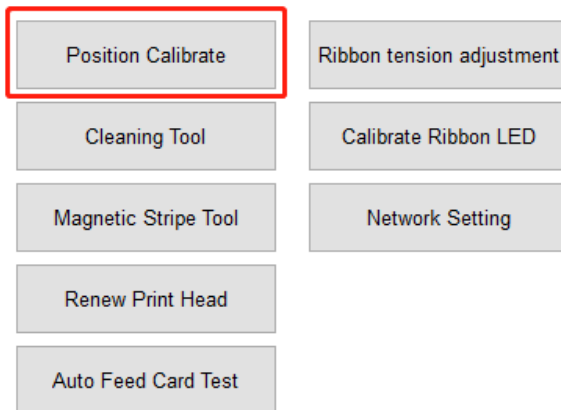
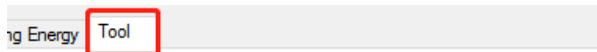

Step 2: Place some white card into input hopper, then click” Print test chart ”

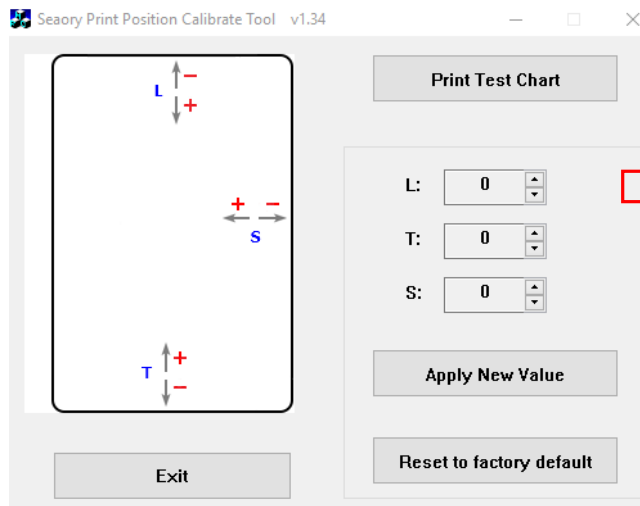

Print test card picture

8.2 Seaory iCARDE card design software

After all the above steps are completed, relevant software can be used to print and test the card printer. You can also do print test through Seaory’s iCARDE software. For details, please refer to Seaory iCARDE manual.



9. Cleaning and maintenance

9.1 Replace cleaning roller

The purpose of the cleaning roller is to absorb the dust on the card and improve the printing effect.

Replace cleaning roller after every roll of ribbon use up or one time per month. Operating details please refer to 5.1 section.

9.2 Cleaning card moving path

Deposition of dust or contaminants inside the card printer may cause damage to important parts and affect the printing effect. Therefore, it’s recommended to clean the printer when changing the ribbon or at least clean one time a month.

- (1) Driver operating guide please refer to 7.15 section.

(2) LCM operating guide:

Step 1: Take out the cleaning card from the accessory box and remove the 3M hyaline layer on cleaning card's both sides and put it into input hopper.

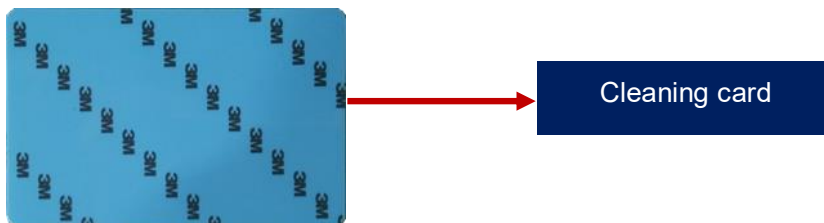

Step 2: When Card printer shows "Ready", press "OK" one time, then press ">" two times.

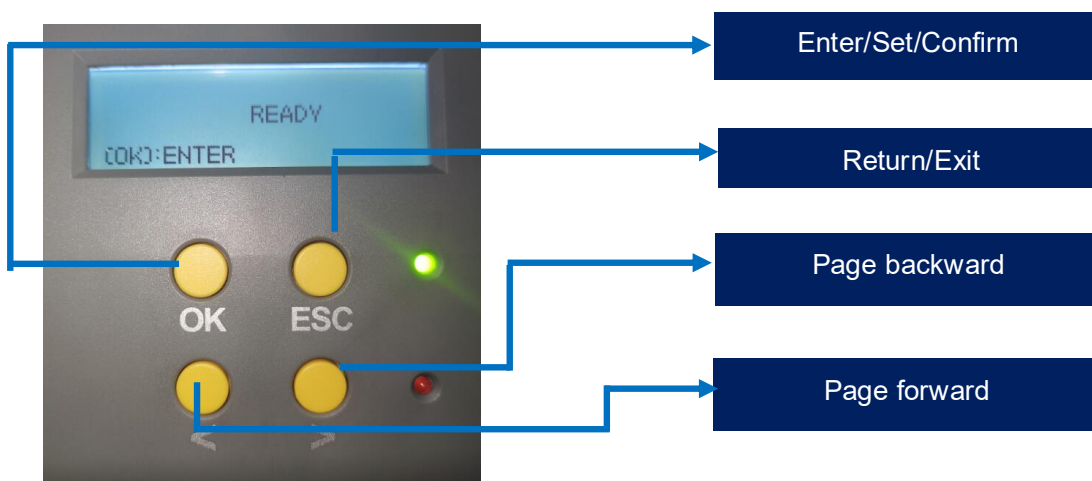

Step 3: LCM show "Clean function" press "OK" one time. Then LCM will show "Open the cover".



Step 4: Open the cover, take out ribbon cartridge, and then close the upper cover.

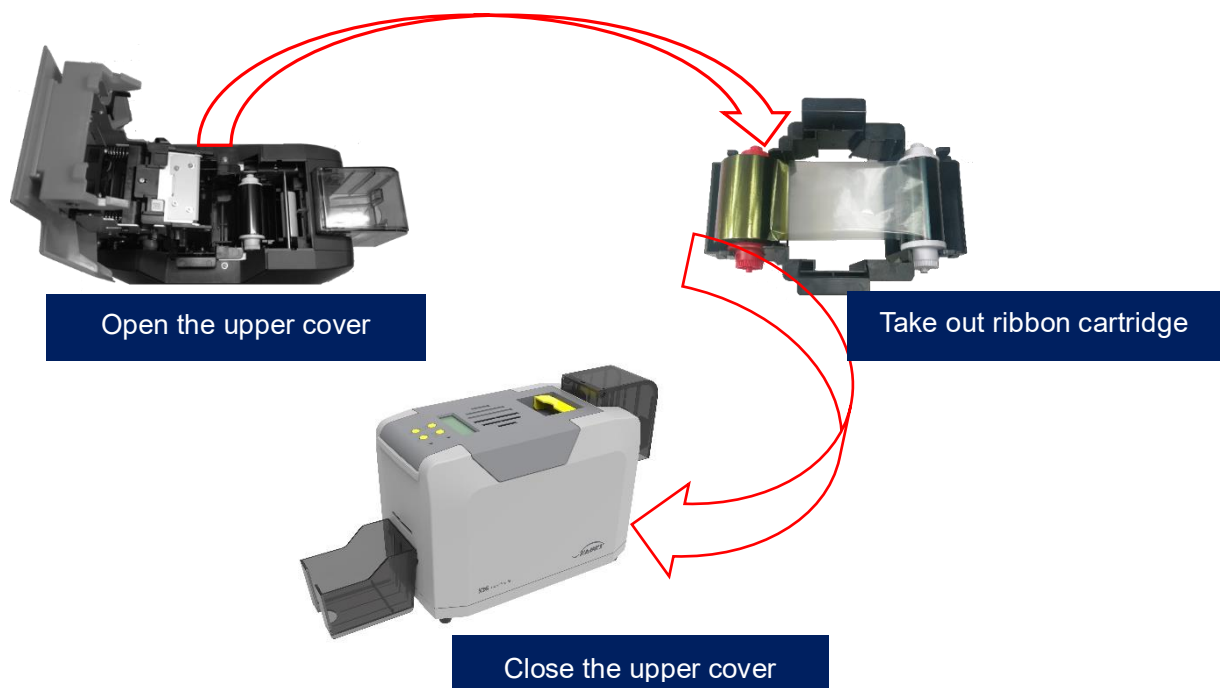

Step 5: Press "OK" one time. The card printer will start to cleaning.



Step 6: The cleaning card will be exit from card exit mouth after finished cleaning. After it, please install the ribbon cartridge and close the upper cover.

9.3 Cleaning print head

Print head is the most important and valuable part of card printer. Like a car, it's a consumable product that will eventually breakdown. Only continuous attention to maintenance can extend it's lifespan.

Maintenance method is to use the cleaning stick for cleaning. Clean it every time you change the ribbon or printing effect is poor. And it's also recommended to clean the print head once a month.

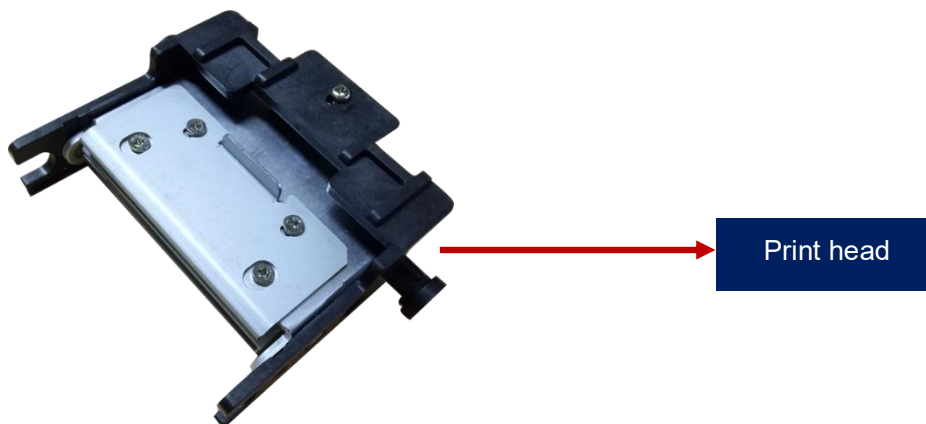

Cleaning print head steps:

Step 1: Take out cleaning stick from accessories box.



Step 2: Turn off the card printer, open the upper cover and find the print head show in below picture.



Step 3: Wipe the print head one direction, from left to right or right to left with cleaning stick. Do not wipe back and forth. Generally wipe 3-5 rounds will be ok.

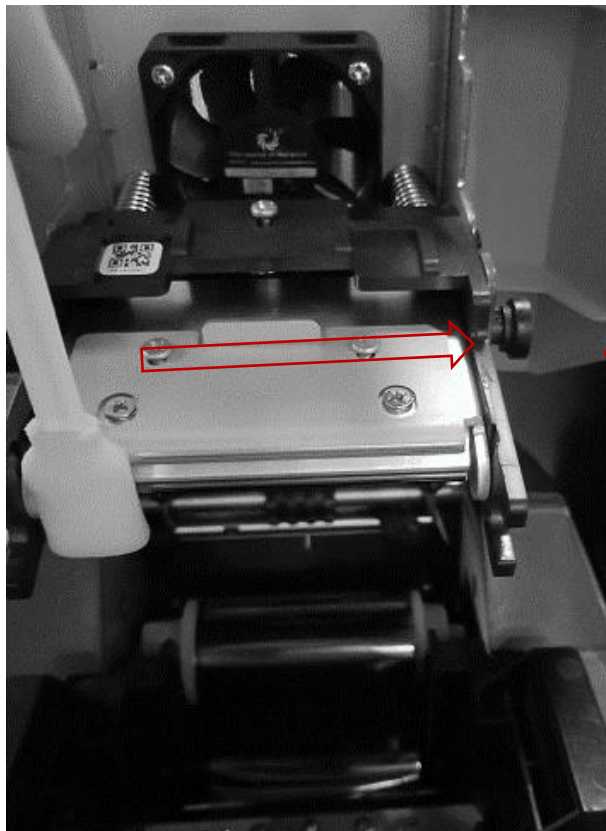

Wipe in one direction

! Avoid print head direct contact with metal objects, sharp objects or fingers, and do not contaminate any liquid to clean the print head.

10. Replace print head

In the long-term use of printer, when the expiration of lifespan or no regular cleaning or maintenance or artificial damage, the printing will appear broken needle, blank vertical stripes etc. Then you need to replace the print head.

Replace print head steps:

Step 1: Take out the new print head and record it's serial number.



Step 2: Turn off the card printer, open the upper cover and find the print head show in below picture.

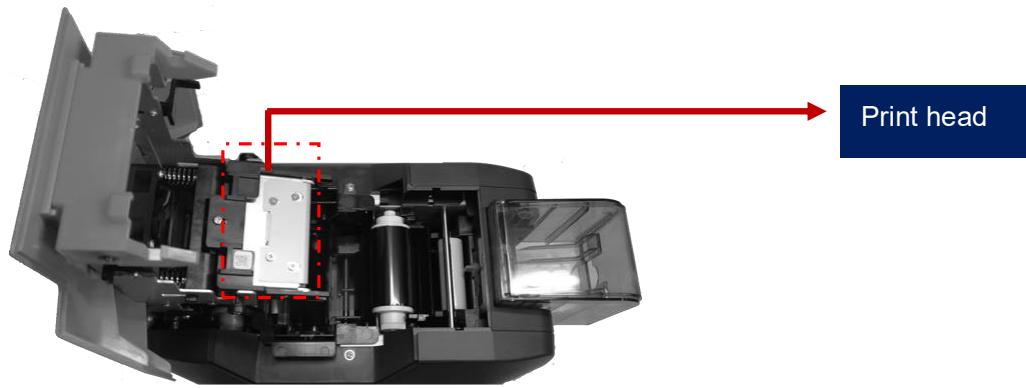

Step 3: Look closely at the mounting structure on both sides of the print head.

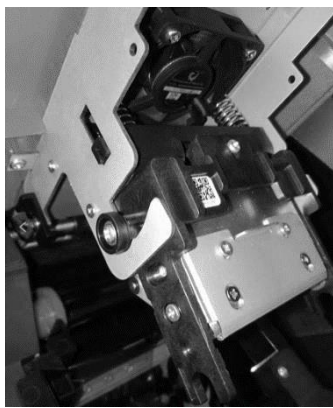

Side

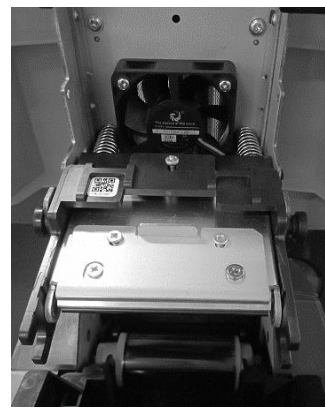

Front

Step 4: Remove print head

Hold the print head on both sides by hand and press the print head toward the cover. At this time, the spring will be compressed. Loosen the print head when the small cylinder on both sides of the print head comes out of the metal hook.

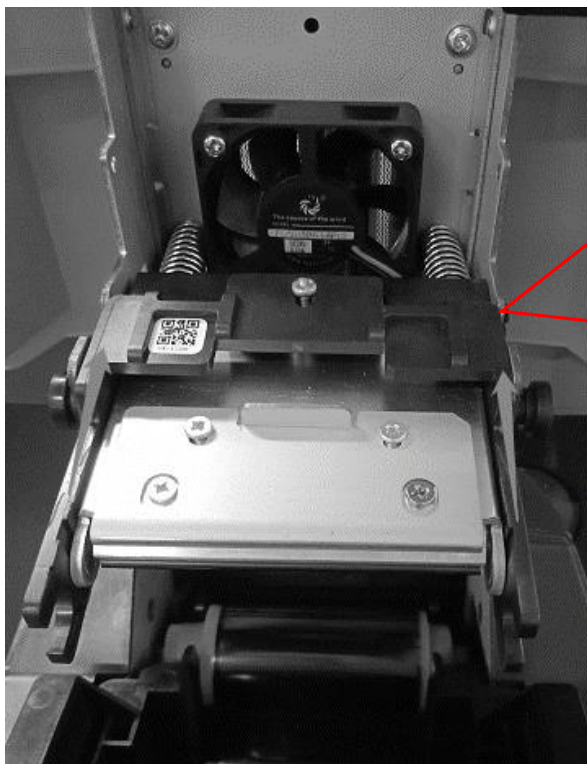

Find the wiring and pull it out from the wiring plug with your hand.



Step 5: Install new print head

Take out the new print head and connect the print head wiring to the wiring plug. Note that the direction of the wiring plug must be the same as the print head interface.



Finished

Clip the print head onto the hook and hold part A against part B until the cylinders on both sides of part A are stuck on the metal hook.



Finished

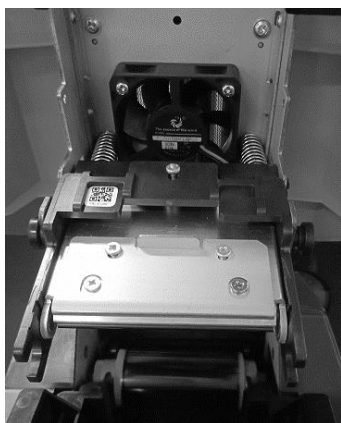

Step 6: Enter the new print head serial number into the driver. Failure to enter may result in an abnormal print.

Open "Printing preferences", click "Tool", find and click "Renew print head".

The image illustrates the process of entering a new print head serial number. It shows the physical print head with a barcode and the serial number **TMZ 86-00313 CHN R2813**. The software interface includes a 'Tool' menu with 'Renew Print Head' selected, and a 'Seatory Print Head Replacement Tool v1.34' window with a 'Print Head Barcode:' input field. Red arrows indicate the flow of information from the physical serial number to the software input field.

11. Common fault codes and Solutions

The card printer happen to meet some faults in the process of use, and the most direct way to judge the faults is to see the code displayed on the LCM display screen of the card printer. Find out card printer fault code, you can clearly know the fault reason and find a solution.

Fault code	Fault name	Reason	Solution
CODE:43	Ribbon missing	Ribbon uninstalled	Install ribbon according to operating manual
CODE:46	Ribbon out	Replace a new ribbon	Replace a new ribbon according to operating manual
CODE:5F	Card out	Place some cards	Place some cards according to operating manual
CODE:21	Cover open	Upper cover has not closed	Close the upper cover
CODE:22	Reject box open	Reject box is open	Close reject box
CODE:23	Reject box full	Reject box is full	Take out defective cards
CODE:51	Card feed error	Thickness of card feeding entrance setting is wrong	Adjust the feed card thickness according to the operation manual
CODE:11	Card jam	Unusual card jam	Clean the card moving roller regularly according the to operation manual
CODE:44	Ribbon unsupport	Ribbon chip unsupport	Check the ribbon details by the driver or LCM, and contact the local distributor

12. FAQ

12.1 When card print no action

- Verify that the card printer driver is installed correctly
- Check power and USB cable connections
- Check ribbons and cards
- Print test picture

12.2 When print out the blank card

- Check ribbons and cards
- Please reset the card printer's parameters by driver (Print option – Tool - - Position Calibrate - Reset to factory default) Or adjust the L,T and S value
- Try to print again after adjust
- Check whether the printing card is CR-80 standard

12.3 When partial or error printing

- Check the card printer's setting
- Check the cable and ribbon
- Make sure the cleaning roller is clean
- Check the card is clean or not
- Check the print head

12.4 When the printed card has a defect

- The card surface is not clean
- Please clean the card printer by cleaning card
- Print head is not clean or damaged, need to wipe cleaning or replace
- Check whether the cleaning roller need to replace

12.5 When the printed card appears white line

- Check whether the ribbon is proper installed
- Check whether the print head is not clean or damaged

12.6 When the printed card appears white vertical or color lines

- Print head maybe was damaged

12.7 When the printed card appears blurry image

- Check whether the ribbon is proper installed
- Check whether the cleaning roller or print head is not clean
- Check whether the printing card is CR-80 standard