

Seaory S25 Desktop Single-side Card Printer

Quick User Guide



Shenzhen Seaory Technology Co., Ltd.

1. Unpacking and inspection

1) Open the top cover, you will see following items:

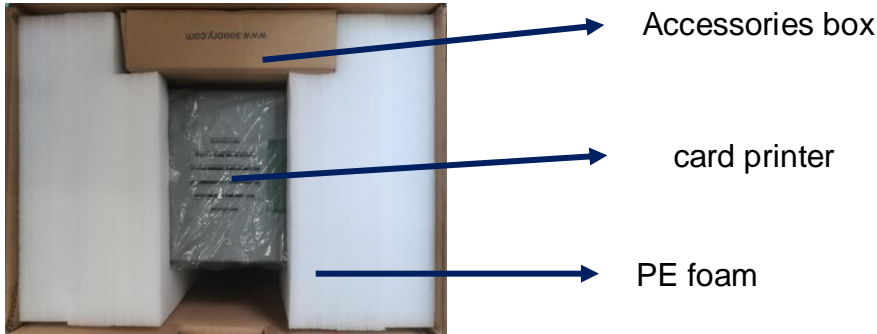

2) Accessories list:



1PC power adapter



1PC power cable



1PC USB cable



1PC ICARDE software CD



1PC cleaning roller



5pcs cleaning card



1PC warranty card



1PC cleaning stick

i If the above accessories are in short supply, please contact your local distributor immediately.

3) Appearance introduction:

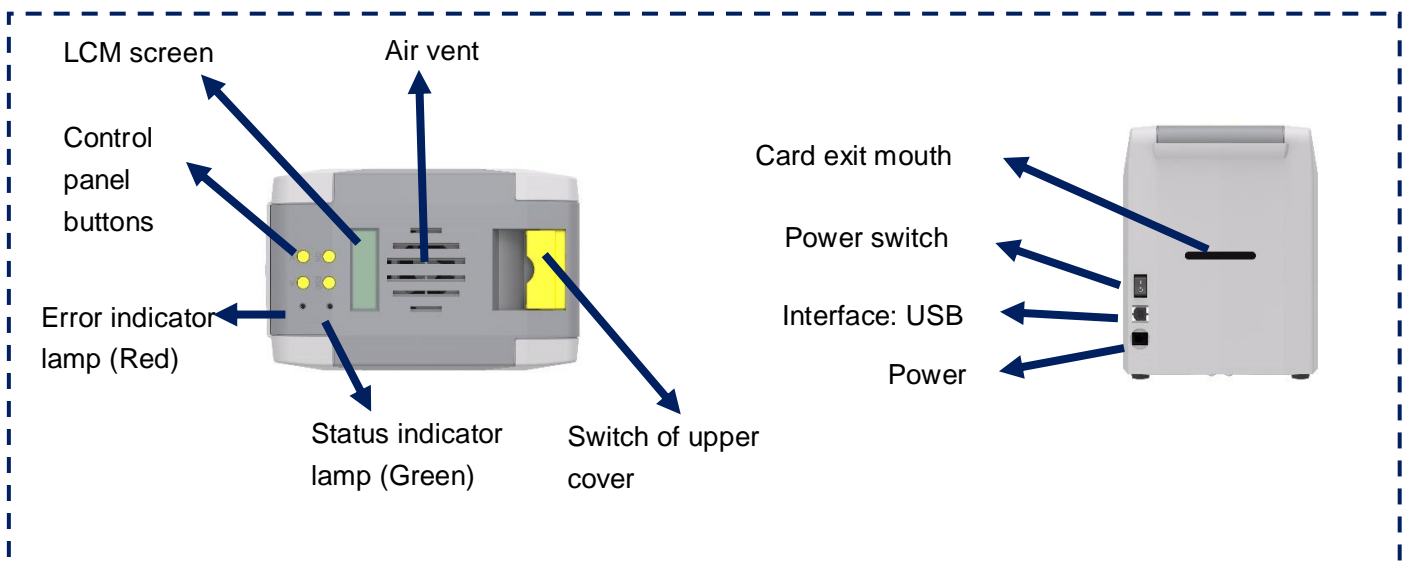

2. Cleaning Roller Installation

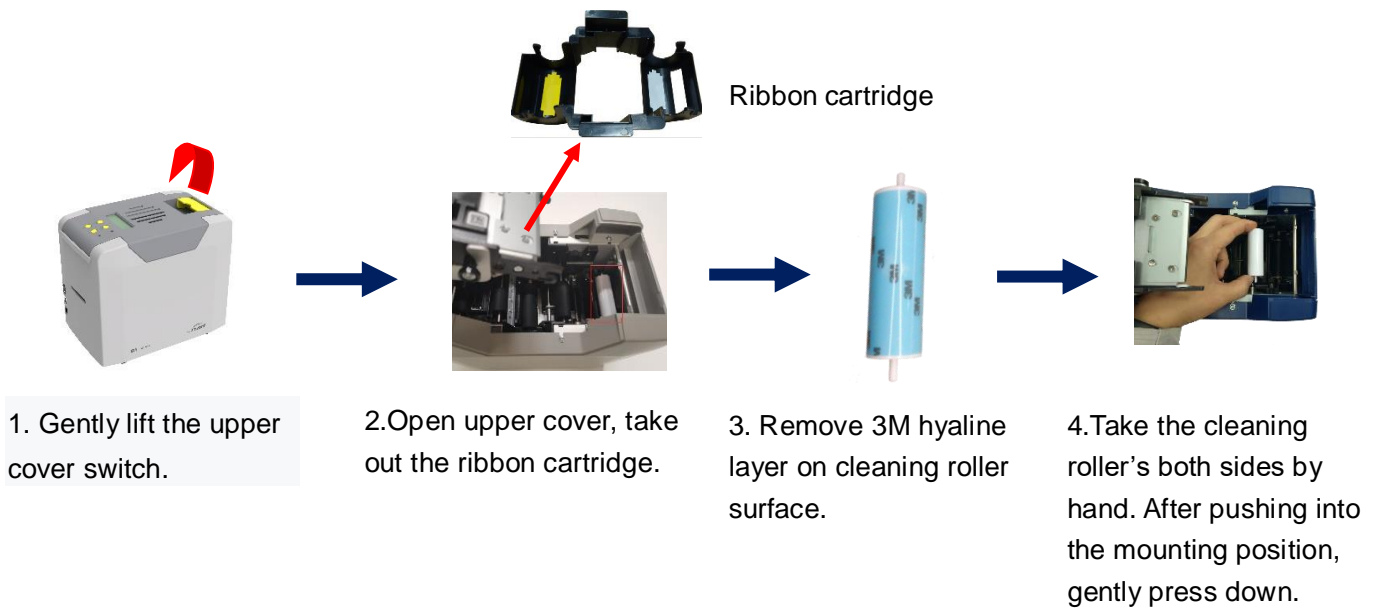

The purpose of the cleaning wheel is to absorb the dust on the card and improve the printing effect. Replace cleaning roller after every roll of ribbon use up.

Note:

To not interfere with the card printer work normally, when use the card printer for the first time, please take out the pearl cotton inside the card printer as shown below (the card printer does not need to be placed in the pearl cotton when the card printer works normally, please refer to "Use Manual")

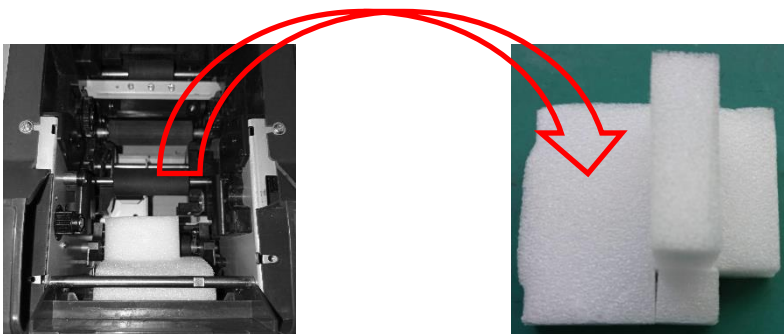

3. Ribbon Installation



1. Open the upper cover, take out the ribbon cartridge, install the ribbon into the cartridge according to the color direction.

2. Yellow roller supply with unused ribbon. White roller supply with used ribbon.

3. Take ribbon cartridge's side, Yellow roller close to the Back-end card exit mouth, install the ribbon cartridge.



In order to ensure the normal use of the printer, please use Seaory original ribbon.

4. Feeding card

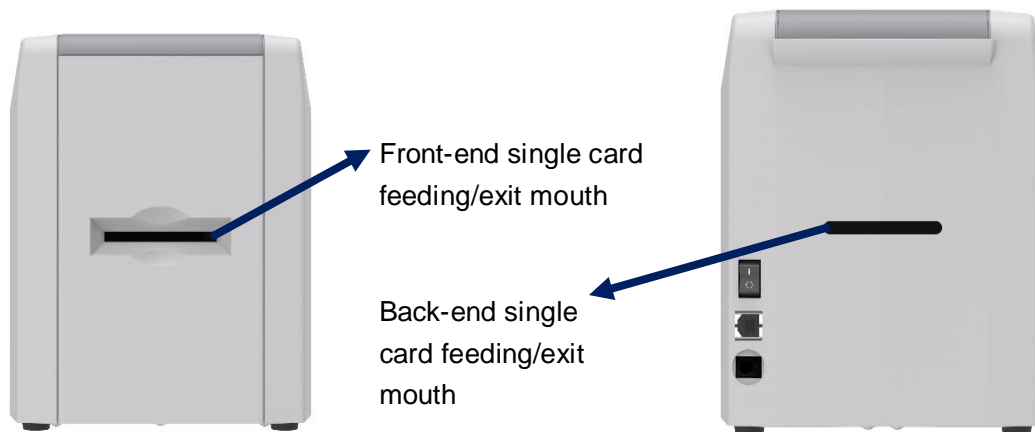

When the card printer is ready, put the card into the front-end or back end card feeding/exit mouth, the card printer will automatically insert the card after detecting the card.

5. Driver installation

5.1 Hardware Connections

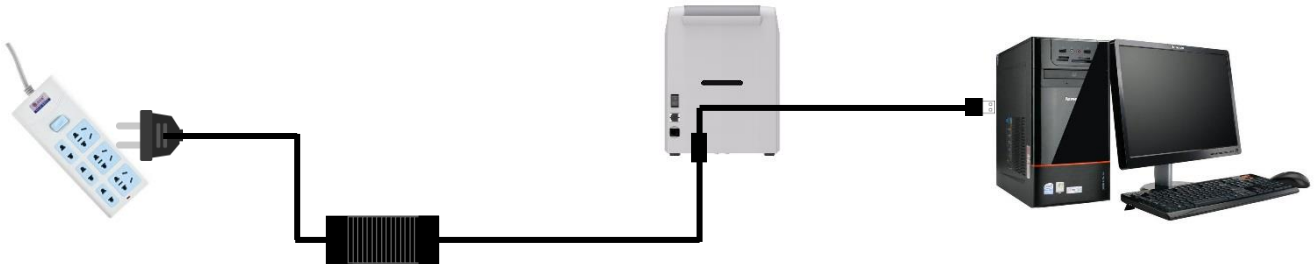

Power adapter 24V connector is inserted into card printer power interface. Connect the power cable to the power adapter. Then plug the power cable into the mains socket. But do not power on until the driver installation is complete.

Connect the square port of the USB cable to the card printer and connect the flat port to the USB port of the computer.

5.2 Install the Driver

Download the installation package from the CD in the accessory box or the company's official website www.seatory.com. And install the driver according to the software installation process prompts or the product instruction manual of this model

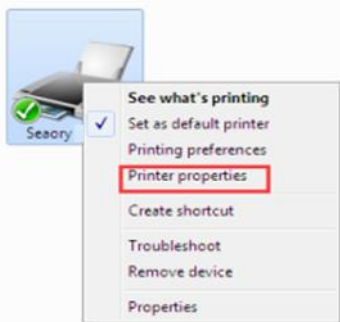

6. Print test

Method 1: Driver Test Page

Step 1: In the list of printers and devices → right-click the Seatory S25 printer icon → printer properties.

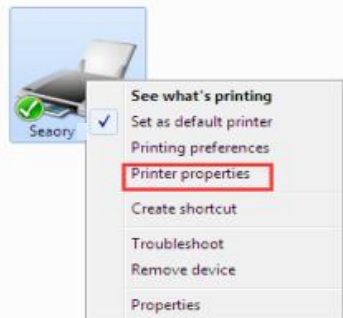

Step 2: After enter below picture interface, place some white card into input hoppers, then click "Print Test Chart"

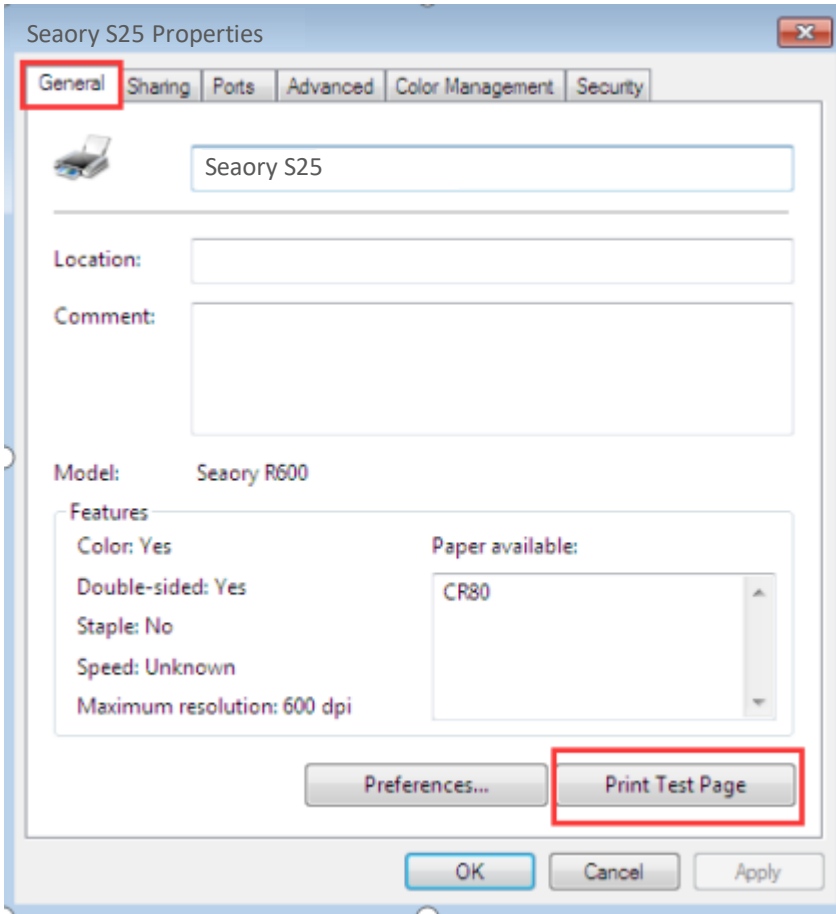

Step 3: When print out the following card, that's mean the driver program and hardware installation are normal.

